

NUMBER 1/2022

ISSN 2357-206X

RESEARCH REPORT SERIES

**Wetback Research: Thermodynamic
Flow Characteristics of Passive
Thermosyphon Energy Transfer
from Independent Heat Source to
Remote Storage Using Both Direct
and Indirect Systems**

Garry Cruickshank

Don Mardle

**[doi.org/10.34074/
rsrp.094](https://doi.org/10.34074/rsrp.094)**

ePress
Research with impact



Wetback Research: Thermodynamic Flow
Characteristics of Passive Thermosyphon Energy
Transfer from Independent Heat Source to Remote
Storage Using Both Direct and Indirect Systems

By Garry Cruickshank and Don Mardle

Wetback Research: Thermodynamic Flow Characteristics of Passive Thermosyphon Energy Transfer from Independent Heat Source to Remote Storage Using Both Direct and Indirect Systems by Garry Cruickshank and Don Mardle is licensed under a Creative Commons Attribution-NonCommercial 3.0 New Zealand licence.



This publication may be cited as:

Cruickshank, G., and Mardle, D. (2022). Wetback Research: Thermodynamic Flow Characteristics of Passive Thermosyphon Energy Transfer from Independent Heat Source to Remote Storage Using Both Direct and Indirect Systems. Unitec ePress Research Report Series (1/2022). <https://doi.org/10.34074/rsrp.094>

About this series:

Unitec ePress periodically publishes research report papers that highlight findings of completed research projects by current members of staff and their research associates. All papers are blind reviewed. For more papers in this series please visit: www.unitec.ac.nz/ePress/index.php/category/publications/ePress-series/research-reports-ePress-series/

This paper is published in association with Manukau Institute of Technology.

Cover design by Penny Thomson.

Contact:

ePress@unitec.ac.nz
www.unitec.ac.nz/ePress/

Unitec Institute of Technology
Private Bag 92025, Victoria Street West
Auckland 1142
New Zealand

ISSN
2357-206X

Wetback Research: Thermodynamic Flow Characteristics of Passive Thermosyphon Energy Transfer from Independent Heat Source to Remote Storage Using Both Direct and Indirect Systems

Garry Cruickshank and Don Mardle

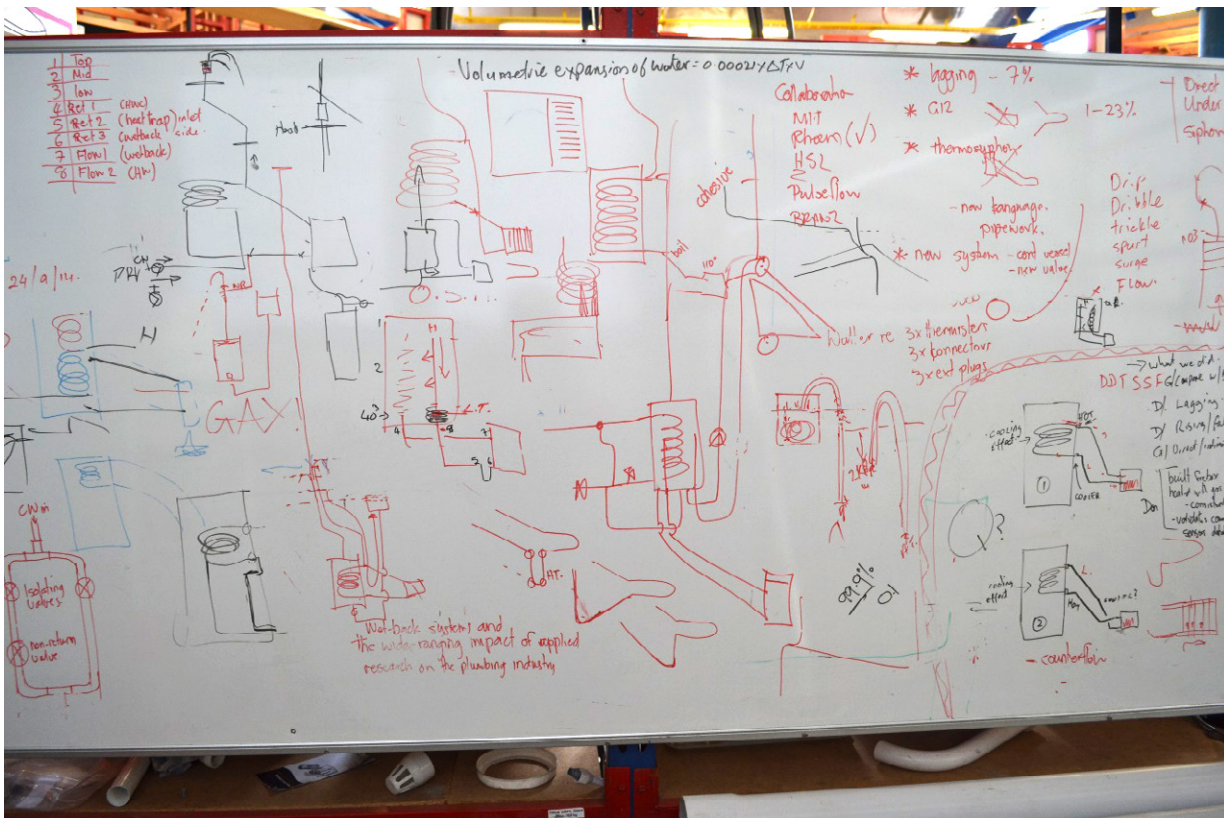

Figure 1. Whiteboard used to plan pipe layouts forming a wall in the workshop.

About the authors

Garry Cruickshank started a 10,000-hour (five-year) apprenticeship in plumbing and gasfitting in 1971, and obtained a Trade Certificate in Plumbing and Gasfitting and an Advanced Trade Certificate in Plumbing. After moving to Auckland he worked in commercial plumbing and industrial gasfitting. He was a member of the Auckland Apprenticeship Committee for four years, and spent two years on the National Apprenticeship Committee.

Moving back to the Waikato in 1986, he owned a contracting company, opened a Gas Centre and became area manager for the Natural Gas Corporation. In 1987 he started work at Unitec as a Lecturer in the Plumbing and Gasfitting Department, becoming Programme Leader and later Head of Department. During the time he ran the department, the number of full-time equivalent students (mainly apprentices) went up from 65 to 450. During that time an electronic textbook (ebook) was produced (under the direction of Don Mardle) for the plumbing and gasfitting industry, which was generally considered as the most advanced trade-teaching tool in the world at that stage.

During a 3.5-year sabbatical (2009–13) he wrote training programmes and technical instruction books for a range of industry organisations, and was employed as a Gas Auditor for the Plumbers, Gasfitters and Drainlayers Board for two years. Garry returned to Unitec from 2013 to 2016, and left to take up a position at Auckland Council as a Technical Trainer, training building inspectors and processors. In 2019 he moved into the Regulatory Compliance Department, in the Targeted Initiatives team. He now trains compliance investigators and deals mainly with complex issues related to dangerous and insanitary buildings.

Don Mardle left school and started work in a factory as a process worker making TV and stereo cabinets. After a great year, and lots of time to think, he applied to, and was accepted for, teacher's college, where he trained for three years, before heading to Whangarei for a short stint of teaching. This was an important time, and although a love of education became entrenched in Don's psyche he soon became disillusioned with the inadequacies of the system, and began looking for something new.

Influenced by new, creative and skilled friends with trades, Don quit teaching, took a big pay cut, and began a carpentry apprenticeship. Building soon became his new love, which, like education, quickly became ingrained. While still an apprentice, Don completed his Trade Certificate (winning an award for the top candidate of his year), and also took on night school to train for his Advanced Trade Certificate. Then, after 16 fantastic and diverse years contracting in New Zealand, Sydney and London, and developing additional skills along the way in shopfitting, furniture and cabinetmaking, and wooden flooring, it all fell apart with a career-ending hand injury.

Then a long and rewarding academic career began, along with a long and rewarding friendship with Garry Cruickshank. Don was able to combine his two great loves – education and building – and taught carpentry for a couple of years. He was then seconded to Unitec's Plumbing Department, which had just come under Garry's leadership, and so an extraordinary journey began – and Don accidentally became fascinated with the science and craft of plumbing and gasfitting. Garry and Don worked together to contribute to a massive increase in plumbing, drainlaying and gasfitting student numbers, and dramatic improvement in retention and success. Over a period of about four years, Don designed and project managed the development of a world-leading, comprehensive, interactive, online learning resource for plumbing, gasfitting and drainlaying apprentices, along with a variety of electronic support tools, databases and a unique assessors' tracking system.

Garry had a sabbatical for several years, during which Don was seconded to other parts of Unitec, and led online and distance-learning development programmes in courses such as veterinary nursing. Garry returned from his sabbatical, and he and Don teamed up again for this wetback research project – something they had been talking about for more than a decade. Don designed the unique firebox, Garry fitted it up and commissioned the gas componentry, and together they designed and enacted the research project.

In 2017 Don and Garry both moved on to positions at Auckland Council and together ran the award-winning in-house training school for building officers who process plans for consent, and inspect buildings during construction. Don eventually left Auckland and moved to rural Hawkes Bay, where he worked in the regulatory environment, training building officers for a further two and a half years. Don is now an independent contractor working in the construction industry, and still has an unnatural interest in plumbing.

Table of Contents

xx	About the authors.
xx	Proviso
xx	Executive summary
xx	Recommendations
xx	Terminology
xx	Introduction and background.
xx	The genesis of this research project
xx	Aims and objectives
xx	Methodology
xx	Pipe volumes.
xx	Surface area of pipes.
xx	Efficacy of wetbacks
xx	Measurement and recording of results
xx	Resources
xx	Water supply to system
xx	Results/Findings
xx	Scenario 1. Types of wetback.
xx	Scenario 2. Under what conditions, if any, is 25mm pipe better than 20mm pipe?
xx	Scenario 3. Given the different requirements of G12/AS1 and AS/NZS 3500.4, are the gradients specified more efficacious than any other?
xx	Scenario 4. Is there a maximum or optimum distance after which performance of a wetback suffers, either horizontally or vertically?
xx	A word on insulation (lagging)
xx	Scenario 5. Indirect systems. In terms of efficiency, is it better to connect the wetback to the coil, or the wetback to the main body of water in the storage vessel, with the coil used to transfer heat to the consumed water?
xx	Scenario 6. Is it necessary or desirable to have return pipe at the same gradient as the flow pipe?
xx	Scenario 7. Does a commercially available surge valve have any noticeable effect on any system, or is the same effect provided by a heat trap?
xx	Scenario 8. Counterflow. What effect, if any, does reversing the flow and return connections from the wetback to the HWC have on the efficiency or safety of the system?
xx	Scenario 9. At a standard distance of 10 m (horizontal), compare the differences between a conventional adjacent configuration and an over/under configuration with both 20 mm and 25 mm pipe, and conventional/counter-flow connections.
xx	Scenario 10. And then we did something very stupid.
xx	Discussion.
xx	General principles of a syphon
xx	Stratification
xx	Water loss at high temperature
xx	Counterflow system
xx	Configuration of return pipe
xx	Full of sound and fury, signifying nothing
xx	Theory of water movement within wetback pipes
xx	Conclusion
xx	Other systems: Solar and pumped – extrapolation
xx	Solar
xx	Pumped systems
xx	Recommendations
xx	References
xx	Appendix 1. G12 AS1
xx	Appendix 2. AS/NZS 3500.4.2018
xx	Appendix 3: Schedule of tests
xx	Appendix 4 Recommended systems
xx	Appendix 5: General photos

Proviso

In most instances, the primary purpose of a solid-fuel heater is to provide space heating; in such circumstances heating water via a wetback is a secondary benefit. This research has been designed to establish the best configuration for water heating – any increase in water-heating efficiency is at the cost of a reduction in heat output for space heating.

Further, a decrease in heat output (space heating) could have implications for published figures on solid-fuel heater emissions and efficiency of authorised burners in relation to Clean Air Zones.

Executive summary

The method of heating water by means of a water jacket installed in the firebox of a solid-fuel burner, connected by pipes to a hot-water cylinder (HWC), was once commonplace in New Zealand, but has become less so in recent years. These systems, known as wetbacks, are covered by Building Code Clause G12, but considerable confusion has been caused by conflicting rules specified in the two main compliance documents, G12/AS1 and AS/NZS 3500.4 (hot water). In both compliance documents, wetback systems are defined as '*uncontrolled heat sources*' with specific rules and limitations that stipulate how they are to be installed, and to keep them safe. However, other than common safety rules, each has entirely different 'mandatory' installation rules that affect the efficiency of the systems.

They couldn't both be right, but they could both be wrong.

This is further confused by another standard, NZS 4603:1985, being mentioned in G12 as 'another acceptable solution' and differing from and contradicting both of the above. This standard is often quoted by manufacturers in their instructions.

One driver of this research, from a regulatory view, was to determine which of the two main compliance documents was correct, if either.

By building a wetback heater with measurable and constant inputs, and measuring the results using a state-of-the-art data logger, we were able to measure and record the efficacy of different pipe configurations and different systems.

A series of practical tests was conducted over a two-year period, to determine the effect different pipe configurations (pipe diameter, length, gradient, etc.) had on water circulation, and thus the efficacy of different installations.

The authors tested systems where there was a separation between the heater and HWC at 1.0 m, 3.0 m and 10.0 m horizontally, and ranging from 100 mm to 3.0 m rise (vertical separation), as well as indirect heat transfer through a heat exchanger coil within the storage vessel, and direct systems in which the consumable water flows through the wetback and is heated directly. We also tested a once very popular remote system, known as an 'over/under' system, where the heater and storage vessel are separated by a room; in this case, the flow pipe runs through the roof space and the return pipe runs under the floor.

We also included a number of comparative tests in which we fitted a proprietary 'surge valve,' comparing those results with identical installations with no valve. We concluded this valve had no measurable effect.

What we were able to show is that much of what we thought we knew about wetbacks (uncontrolled heat sources), and most of what is taught to apprentices and tradespeople alike is fundamentally wrong. With the exception of basic safety principles requiring wetback systems to be open vented, neither of the two compliance documents deemed to comply with Building Code Clause G12 appears to have been based on any sort of research, and the systems specified are among the least effective configurations we tested.

Various incontrovertible and 'known facts' taught to generations of plumbers, and examined as part of their registration requirements, have been shown by our research to be fundamentally flawed.

All available textbooks, as well as all the teaching material reviewed, stipulate that water is moved through the pipes due to thermosyphon (convection currents), but we discovered, and demonstrated unequivocally, that this is only true to a limited extent,

and that, in many systems, the main motivation force is in fact provided by a series of small steam explosions. This has serious implications in the design and application of this principle to other aspects of the plumbing trade.

In short, the main conclusions are as follows:

Basing the pipe sizes on distance between heater and HWC is incorrect – a 20 mm pipe is the most suitable size in all circumstances tested.

There is no advantage in a 25 mm pipe in any circumstance tested.

Requiring a minimum or specific rise (away from the heater) in the flow pipe is flawed – any rise will do as long as there is one.

Requiring the return pipe to fall away from the cylinder is counterproductive, and reduces the efficiency of the system.

The return pipe should fall from the cylinder and then rise to the heater, forming a heat trap. Alternatively, a purpose-made heat trap should be fitted.

Taking the flow pipe to the top, and the return pipe from the bottom of the cylinder, is the least effective method – these connections should be reversed (counterflow).

If connecting a wetback to a water heater containing a coil (indirect heating), the least effective method is to connect the coil to the wetback flow and return pipes. It is better to heat the water in the storage vessel directly, and run the consumable water through the coil (indirect heating).

A formula for ascertaining the most effective design (in terms of heat transfer) of a wetback element is suggested.

Once water in a wetback system exceeds a certain temperature, it will generate a series of contained steam explosions, which drive the circulation. This contradicts most explanations for the process, and we believe this is the first time the phenomenon has been documented.

At a certain ‘tipping point’ a process will start that results in an unstoppable and considerable discharge of boiling water out of the open vent pipe. In this process, up to a third of the water in the storage vessel will be discharged before incoming water cools the vessel enough to stop the discharge.

RECOMMENDATIONS

After digesting these findings, we suggest five main courses of action – all need to be done concurrently.

1. MBIE and Standards NZ should consider getting together, recognising that their respective solutions require amending, and set up a joint committee to rewrite the section in G12/AS1 on wetbacks.
2. Modify AS/NZS 3500.4 to align with G12/AS1.
 - a. Encourage Standards Australia to amend AS/NZS3500.4.
 - b. Encourage Standards New Zealand to amend NZS 4603:1985.
3. Teaching organisations should review their teaching material to reflect this research.
4. The Plumbers, Gasfitters, and Drainlayers Board should ensure all examination questions and marking criteria align with these findings.
5. Emissions of authorised burners should be reviewed.

TERMINOLOGY

There is a lot of trade terminology applied to certain aspects of this research. Some textbooks and some manufacturers' instructions confuse or misuse the terms: for example, the term 'wetback' is used for both the heat exchanger unit inside the space heater, and the pipe-work connecting this unit to the storage tank. It is also sometimes used to describe the entire installation including all of the above.

To avoid confusion, we have determined to use standardised terms for specific parts of the installation, and use these throughout. This includes a number of terms we have had to allocate (or invent) as we discovered new phenomena.

Term	Meaning
Wetback	Heat exchanger unit (water jacket) contained within a solid-fuel space heater.
Heater	Usually solid-fuel uncontrolled space heater designed to heat the internal environment, in this case also containing a wetback.
Flow pipe	Pipe leading from the wetback to hot-water storage tank.
Return pipe	Pipe leading from the hot-water storage tank to the wetback.
Rise and fall	The gradient of the pipe in the direction of flow.
Riser	Pipe within a hot-water cylinder (HWC) designed to deliver heated water to the top of the cylinder.
Coil	A heat exchanger contained within the HWC in the form of a coil through which water passes.
Vent pipe	A pipe connected to some part of the system that is open to the atmosphere, and that limits pressure and allows the escape of steam.
Adjacent system	Heater immediately adjacent to the HWC, either sideways or below.
Over/under system	The HWC is at a distance from the heater, separated by some structural element such as a doorway or wall; the flow is taken over the ceiling and the return brought back under the floor.
Direct heating system	The water is heated by the wetback and stored in the HWC; the heated water is used directly, with no other heat exchanger used.
Indirect heating system	The water heated by the wetback is not consumed. The consumed water is heated via a heat-exchanging coil. Thus, the water flowing through the wetback indirectly heats the consumed water. Indirect systems enable mains-pressure supply for consumed water.
Counterflow	Where the flow and return pipes are connected to the HWC in reverse order to the traditional method; that is, the flow is connected to the bottom of the HWC, and the return pipe connected to the top of the HWC.
Conventional	Standard and traditional pipe configuration where the flow pipe is connected to the top of the HWC, and the return pipe to the bottom.
HWC	Hot-water cylinder, being the usual storage vessel in domestic installations. Will usually have an electric element as the default energy source with the wetback as a booster only. Also referred to as a storage vessel or water heater.

Introduction and background

When Garry was serving his plumbing and gasfitting apprenticeship in Tokoroa in the 1970s, the installation of wetbacks was an integral and common part of the job. Hundreds of solid-fuel heaters were installed with wetbacks or wetbacks fitted to open fireplaces. Many were of the over/under type, and the techniques and principles used were commonly known and applied. Only after moving to Auckland in 1979 did Garry discover wetbacks were not commonly installed in that city.

A few years after moving to Auckland, Garry was employed as an Organiser for the Northern Branch of the Plumbers Union, and had occasion to visit the plumbing tutors at Manukau Institute of Technology (MIT). They were in the lunch room discussing a new textbook being written for apprentices, which was to replace the existing Technical Correspondence Institute textbook – the default plumbing text at the time. The only tutor Garry recognised at the time was Ken Doyle, the Head of the Plumbing Department. Discussion turned to wetbacks, and as none of those present had experience of over/under systems Garry drew a sketch of the system on the back of a pie packet, and left them to it.

Some years later, Garry was employed as a tutor at Unitec, and found most of the people who wrote the new textbook (Doyle, 1988–90a, 1988–90b, commonly referred to as Doyle Parts 1 and 2) were now also employed at Unitec. He found that the textbook now included the drawing he had done on the pie packet (with one minor error) some 16 years earlier.

The same drawing with the same error had also been incorporated in NZS 4603.

While the teaching of hot-water systems at the time was loosely based on Doyle (1988–90a, 1988–90b), it also had to be packaged around Building Code Clause G12 compliance documents – G12/AS1 (see Appendix 1) and, to a lesser extent, AS/NZS 3500.4 (hot water) (see Appendix 2). The problem was that both documents were very restrictive in their coverage and application of wetbacks, covering only systems where the hot-water storage vessel and the heat source were directly adjacent ('adjacent system').

But there was an even bigger problem – the rules spelled out in each document were not only different, but they directly contradicted each other. How it is that an international standard, recognised by the New Zealand Building Code as the Verification Method (G12/VM) for G12 hot water, could contradict the Acceptable Solution (G12/AS1) from the same Building Code clause for over 20 years, and still does, is beyond comprehension.

THE GENESIS OF THIS RESEARCH PROJECT

In 1998, Garry was asked to suggest subjects suitable for practical research projects at Unitec, and came up with a list of five major industry projects including a suggested wetback project. This was accepted with some enthusiasm by the research committee of the time, who then promptly shelved the idea when they discovered it would cost money.

After Garry was put in charge of the Plumbing Department in 1999, he altered the teaching programme to include a wide range of wetbacks, and included actual installation of an over/under system as one of the practical assessment tasks. When the department produced a new e-book in 2006 to replace Doyle it included a chapter on wetbacks, including an explanatory animation. This was not adopted by other

providers, and also clashed with some fixed ideas of the then Chief Examiner of the Plumbers Gasfitters and Drainlayers Board (PGDB), over how indirect systems should work. For several years in a row, a candidate for Plumbers Board exams was presented with a requirement to draw the pipe configuration between boilers and storage tanks, as shown in Doyle. Candidates who gave an alternative to the model answer (mainly Unitec apprentices) were marked wrong, and in some cases had to have their papers re-marked in order to pass the exam. This was a most unsatisfactory situation.

Garry had several terse disagreements with the Chief Examiner, who refused to countenance the possibility that he might be wrong and was adamant that the indirect method shown in the textbook was the only way of doing it. Unfortunately, other providers continued to deliver material that was supplied by a training organisation, leading to what many of us viewed as an unsatisfactory level of knowledge and substandard skill-set.

When Garry returned to Unitec in 2013 following a three-and-a-half-year sabbatical, he found many of the teaching materials and tasks previously covered had been abandoned, but on the other hand, a new research director was keen on pursuing practical research opportunities. A new proposal detailing the advantages of such a project was finally approved by the Research Committee, which granted \$10,000 towards project costs.

This research project, therefore, commenced some 16 years after first being proposed and accepted.

PURPOSE

While once a common method of heating water in New Zealand, the use of wetbacks connected to storage water-heaters by pipes has been declining for many years – for a variety of technical, environmental and economic reasons.

The authors felt that one of the key problems was the lack of authentic research-based technical information on the correct design and installation of wetbacks, with most textbooks being largely silent on the matter, and the only three regulatory documents (two Standards and a New Zealand Building Code Acceptable Solution) incomplete and contradictory. This was preventing many Building Consent Authorities (BCAs) from approving once-popular systems, because they fell outside the narrow range of systems detailed in the compliance documents.

We felt the first step in standardising the rules regarding this neglected technology was to gather empirical data to determine which, if any, of the specifications detailed in these documents was correct, and to gather data on alternative systems not covered at all.

This included remote systems where the wetback and storage heater are not adjacent (over/under systems), and indirect systems where a heat exchanger is used to enable mains-pressure hot water to be delivered to the end user. Neither of these once-common systems are mentioned in any of the official compliance documents.

Many manufacturers' guides (that is, manufacturers of water heaters and wetbacks) actually do give instructions, but these often fall outside the parameters of the existing codes and standards, and differ so widely (even for identical situations) that it is impossible to reconcile them. When we approached some of these manufacturers, they were unable to enlighten us as to the source of their recommendations, and, in some instances, admitted them to be based on hearsay or personal experience of a staff member.

Some of the installation recommendations seemed to be potentially dangerous, so we felt it important to obtain accurate empirical data from which to draw reliable conclusions and make recommendations to industry and standards-setting bodies to enable new rules to be enacted covering all types of systems based on verifiable evidence.

Garry Cruickshank, Lead Researcher

Aims and objectives

The original aim of the research was to simply test a variety of pipe configurations, with the following variable factors:

- Pipe diameter.
- Distance between heat source and water cylinder to determine optimum and maximum distances (should they exist).
- Height above heater to cylinder connections, i.e., rise – also to determine optimum and maximum rises.
- And, in addition:
 - To test different scenarios and configurations for systems separated by rooms or doorways (over/under systems), for which no data exists, and on which the compliance documents are silent.
 - To compare the performance of direct and indirect (with heat exchanger) systems, for which no data or rules exist.
 - To gather data on different commercially available wetback elements (water jackets), to determine if manufacturer-published outputs are accurate, and determine if any specific design may be best suited to a specific purpose.
 - After analysing these results, prepare reports and recommendations to Standards NZ and the MBIE to facilitate changes to the Building Code and relevant Standards.
 - Rewrite teaching materials, alter training packages and include new chapters in various textbooks.

However, when we started to run practical tests on our research rig, we discovered a number of assumptions based on accepted industry norms to be unsupported by the gathered data. This forced us to repeat a number of tests to confirm the results, while at the same time running newly designed tests in order to try out alternative solutions not previously considered. This had the effect of taking a considerable amount of extra time, as well as changing the focus from simply gathering data on known systems, to comparing that data to new systems.

By the end of the year, we were able to accurately predict what would happen under certain circumstances, if a particular heating method was used in an adjacent system. An understanding of the physics involved in heating water to very high temperatures (above 112°C) and the forces involved in moving that water through pipes using temperature differentials and steam pressure gave us new insights into the causes of known phenomena.

None of this information was previously available, and we now believe we have the basis for postulating previously unexplored principles and theories in this field.

Methodology

As the purpose of the research was to determine the efficacy of different pipe configurations and heat-transfer systems, it was imperative that the method used to heat the water be absolutely consistent – without which the data would be worthless. The method did not need to accurately reflect a standard wood burner (if such a thing could be defined), but rather ensure that the same energy input was used over the same period. A consistent temperature, for each configuration tested, was essential to enable accurate comparisons of configurations. This one factor may explain why there appears to be no such data available anywhere in the world.

As a normal wood-burner output is erratic and inconsistent, depending on type, moisture content and amount of wood burned, we decided to design, build and use a natural-gas burner in a custom-built fire box, which could be calibrated and checked for consistent energy input for each test. We needed access to the burner, as well as the ability to change the wetback type without having to alter the pipe work every time we did that. To that end, we designed and built our own firebox, which incorporated a hinged door with adequate ventilation for combustion air, and an interchangeable side panel to which different wetbacks could be fitted. We then encased the unit with 50mm-thick high-density fibreglass insulation, which we held in place with sheet-metal casing.

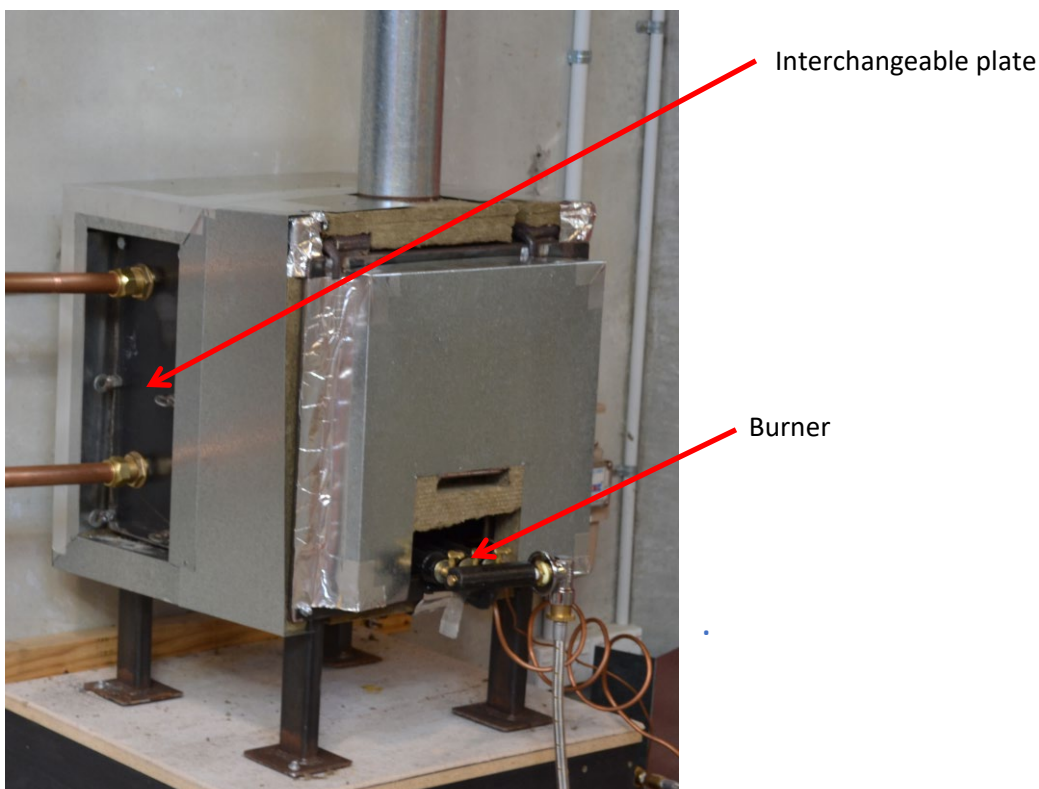

Figure 2. Firebox designed and built for the study.

An off-the-shelf cast-iron gas burner was purchased, and tested using a gas meter in the Unitec gas lab. The burner was labelled as having an output of 40 MJ/h, but testing showed the consumption (input) to be 30 MJ/h – out by 25%! Garry, a licenced gasfitter, rectified this by drilling out the injectors and retesting the burner, until we were satisfied it had an input of 40 MJ/h. A burner safety-control unit was fitted, consisting of a thermo-electric flame-failure device (thermocouple) and pilot flame, and this was connected to a manual gas valve. We installed a standard LPG regulator and pigtail arrangement, and ran a gas line through a standard gas meter before connecting it to the burner using a flexible hose connector. This enabled us to measure the gas pressure both at the meter and at the outlet of the control valve, and to measure gas consumption using the gas meter and a stopwatch.

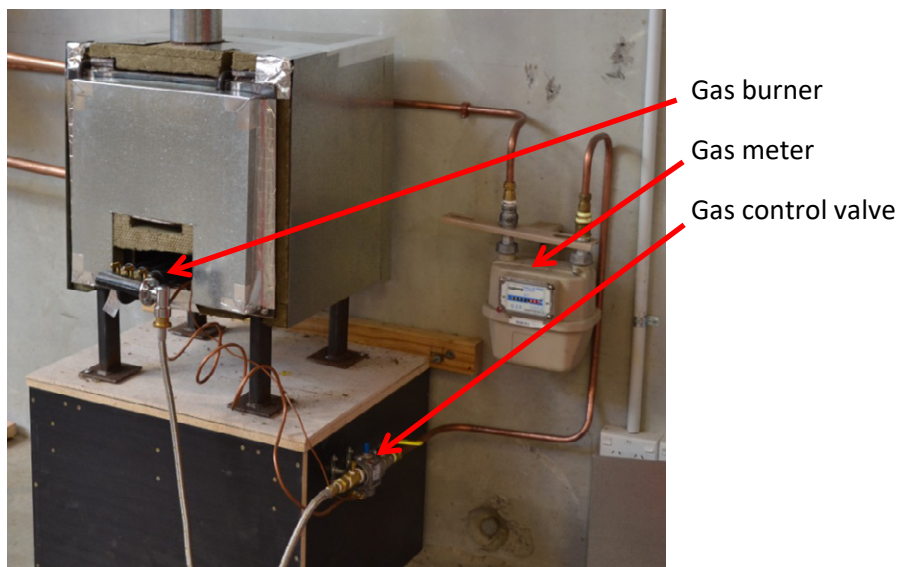

Figure 3. Firebox showing gas burner, meter and control valve.

New Zealand uses a commercial blend of LPG, consisting of 60% propane and 40% butane (by weight, not volume) and an energy content (calorific value) of 104 MJ/M³, approximately 50 MJ/kg.

Gas was regulated to the meter at a pressure of 2.75 kPa (standard LPG operating pressure) and consumption calculated using the following formula.

$$V = \frac{0.01 \times 3,600}{\text{Seconds}} = \text{m}^3/\text{h}$$

where 0.01 is one complete revolution of the meter test dial

3,600 is seconds in an hour

Seconds is the number of seconds taken to complete the revolution

$$P_1V_1 = P_2V_2$$

Pressure correction can then be applied using Boyle's Law:

P_1 is the initial or pipeline pressure

P_2 is the atmospheric or base pressure

V_1 is the volume measured by the meter

V_2 is the true or corrected volume

All the above using absolute pressure (not gauge pressure), we transpose the formula to read:

$$\frac{P_1 V_1}{P_2} = V_2$$

where P_1 is 104.075 (atmospheric plus 2.75 kPa)

P_2 is 101.325 (atmospheric pressure)

V_1 is volume as measured above.

This gives the corrected volume of LPG gas used in m³/h, which is then multiplied by the heat value of 104 MJ/m³ to express heat input to the burner in MJ/h.

PIPE VOLUMES

We reasoned that the movement of water through a given length of pipe by a set amount of energy would be affected by the volume of water within that pipe, so we wanted to know exactly what that volume was. We therefore needed to measure the exact (as near as we could) volume of each piece of pipework. We used standard-gauge copper pipe; however, standard-gauge copper in New Zealand is not standard everywhere, given we are one of only three countries that measure our pipes by internal diameter (ID) not external diameter (ED). Further, the pipe diameters are nominal, rather than exact. The only relevant table we could find in any of the standards was in AS/NZS 5601.1.2013, Table D1, which gives the following volumes per metre.

TABLE D1
APPROXIMATE VOLUME OF PIPE

Pipe material and Standard	Approximate volume of pipe, L/m Nominal size DN															
	15	16	18	20	23	25	32	40	50	63	65	75	80	90	100	110
Copper— NZS 3501	0.13	N/A	N/A	0.28	N/A	0.50	0.79	1.14	2.02	N/A	3.16	N/A	4.55	6.20	8.10	N/A
Copper— AS 1432 (Type B)	0.09	N/A	0.15	0.22	N/A	0.41	0.67	0.99	1.83	N/A	2.92	N/A	4.17	5.75	7.58	N/A

Figure 4. AS/NZS 5601.1.2013, Table D1, pipe volumes per metre. Copyright in AS/NZS 5601.1.2013 is Standards Australia Limited and Crown copyright, administered by the New Zealand Standards Executive. Reproduced with permission from Standards New Zealand, on behalf of New Zealand Standards Executive, under copyright licence LN001457.

We were to use 15 mm, 20 mm and 25 mm in our research, but were unwilling to accept the volumes without checking the veracity of the figures supplied, which is just as well given they were out by between 6% and 11%.

We measured the volume by cutting exactly 1.0 m of each size of pipe and blanking off one end, then filling it with water and emptying that into a calibrated measuring container. We did this 10 times, then measured that volume and divided it by 10. This gave us the volume of water in any metre of pipe measured in millilitres per metres (ml/m).

TABLE 1. CLAIMED PIPE VOLUMES VS ACTUAL PIPE VOLUMES.

Pipe diameter	Claimed volume per metre AS/NZS: 5261 (millilitres)	Actual volume in millilitres
15 mm	130	138
20 mm	280	310
25 mm	500	550

We used this information to calculate the capacity of each of the commercial wetbacks we had purchased (totalling the measured lengths of each section of pipe). To check these volumes, we filled each wetback with water using the same process as above (10 fills totalled and divided by 10). This gave us an accurate volume for each wetback model.

SURFACE AREA OF PIPES

Having determined the capacity (volume) of the pipes, we decided we would also need to determine the surface area of the pipe we intended to use, as this is the primary factor in heat loss. To achieve this, we cut a length of pipe exactly 100 mm long (or as close as we could manage), split it down the middle, flattened it out and carefully measured it. This gave us the surface area of 100 mm of copper pipe in each of the sizes we were to use.

TABLE 2. SURFACE AREA OF PIPES.

Nominal pipe diameter	Surface area of pipe	
	Per 100 mm	Per metre
15 mm	4,300 mm ²	43,000 mm ²
20 mm	6,300 mm ²	63,000 mm ²
25 mm	8,200 mm ²	82,000 mm ²

EFFICACY OF WETBACKS

We purchased three commercially available wetbacks, representing the three most common designs. We will refer to them as the loop, the box and the ladder type, though there are many variations of these available.

Product data for each commercially manufactured wetback included specific outputs ranging from 1.0 kW to 3.0 kW. However, we struggled to understand how these claims could be made, given the variable inputs of a solid-fuel heater, so we asked the manufacturer how these figures were arrived at. He replied that when he bought the company, he found the figures in a drawer, so assumed they were correct! He went on to admit that, to his knowledge, no testing had ever been done.

With this in mind, we wondered whether a general rule could be devised to determine the relative efficiency of different models of wetbacks, and as one did not seem to exist, decided to invent one – we propose the following:

For heated water to begin to circulate (by thermosyphon), the water in the wetback must reach a temperature whereby the density difference overcomes the friction and mass of the static water. Given a constant input (energy) and a common material, the faster the water heats up the sooner it

should start to function.

Therefore, for any heat input and wetback material, the circulation of heated water from the wetback should occur fastest when the wetback provides the largest surface area and the smallest volume of water. The formula we devised is described below:

Surface area (in mm²) divided by volume (in ml) = N. The greater this number, the more efficient the heat transfer. We decided to call this the Cruickshank (or C) number ... because ... well ... we could!

As discussed at the beginning of this paper, not all wetbacks need to be highly efficient, as the more heat removed from the combustion chamber to heat water the less efficient the combustion process, the higher the level of pollutants generated, and the less heat available for the primary function of space heating. In many cases, therefore, a wetback with a very small output might be preferable as a hot-water booster only, but in some cases a greater heat output is desired for quick hot-water recovery.

We then calculated the surface area of each wetback and, using the formula described above, found the Cruickshank number for each wetback unit. This showed that higher C numbers were consistent with greater measured outputs.

TABLE 3. C NUMBER COMPARED TO MANUFACTURER-CLAIMED OUTPUT FOR COMMERCIALY AVAILABLE WETBACKS.

Model	Volume (ml)	Surface area (mm ²)	C number	Manufacturer-claimed output (kW) (Actual tested)
Ladder	700	2 25 mm 300 5 20 mm 220 Total 118,500	169.285	3-4 kW (2.6 kW)
Loop	450	750 25 mm Total 61,500	136.666	1.6 kW (1.7 kW)
Box	1350	35,775 mm ² 2 + 28.175 Total 99,725	73.870	2.1 kW (1.3 kW)

Having determined that the formula appeared to be credible, at least in relation to manufacturer-claimed output, we then set about (as an exercise) seeing whether we could design a better wetback – one specifically designed to extract the maximum heat. This was not difficult to do, as the ratio of area to volume is improved by simply reducing the diameter of the pipes and including more of them. We came up with several theoretical designs we figured would be more efficient than any currently on the market, and even started to build a couple, but in the end decided that this was not the purpose of our research, and that others could do that if they wished.

However, to prove the point, we did build one, based on the ladder design (subsequently called the Unitec Ladder). The Unitec Ladder wetback design reduced the top and bottom pipes to 20mm, linked by as many 15mm pipes as could be fitted. The C number for this wetback is shown in Table 4.

TABLE 4. C NUMBER FOR THE UNITEC LADDER WETBACK.

Model	Volume (ml)	Surface area (mm ²)	C number	Manufacturer-claimed output (kW)
Unitec Ladder	600	220 mm 340 1115 mm ² 230 Total 151,630	252.716	N/A

Testing of this unit (detailed later in the report) in fact did confirm that our design was the most efficient, and after a series of tests under various conditions to set a baseline for comparisons for the actual wetbacks, we ended up conducting the majority of the research on pipe configurations using the Unitec Ladder.

MEASUREMENT AND RECORDING OF RESULTS

The purpose of a wetback is to heat water, so to ascertain the efficiency of each configuration had to involve measuring temperature rise over time. Not all the water in the storage vessel is heated at once, and it is known that a certain amount of stratification occurs within most hot-water storage systems, so we had to decide how to measure results. We were also very keen on measuring actual flow, to determine how much of the flow was uniform, and how much, if any, was due to surges often anecdotally 'observed' in wetback systems.

Following extensive consultation with a number of industry specialists, it was determined that the flow rates would be far too small to allow monitoring with any currently available technology, and certainly within the price range the project could afford. So we settled on measuring the temperature using the very latest state-of-the-art data logger, an Almemo 5690-2M, supplied and calibrated by Teletherm Instruments Ltd. The data logger was set up to record readings from eight different thermocouple temperature sensors.

After some experimentation, we placed the sensors in the following places:

1. Top of the HWC.
2. Centre of the HWC.
3. Bottom of the HWC.
4. Flow pipe as close as possible to the firebox.
5. Flow pipe as close as possible to the HWC.
6. Return pipe as close as possible to the HWC.
7. Return pipe as close as possible to the firebox.
8. Initially inside the firebox to determine temperature.
 - a. After we had proven the consistency of the temperature in the firebox, this thermocouple was moved to the centre of the return pipe.

Although there were insufficient sensors to allow extremely accurate measurement of total heat input into the water, we used a method that gave what we believe to be more than adequate estimates for comparative purposes, using the following method.

1. Measure the water temperature in the HWC at points 1, 2 and 3.
2. Add these together and divide by three to obtain an HWC average start temperature.
3. Measure water temperature at these same three points at set intervals, and repeat the averaging process each time.
4. Calculate average temperature rise.

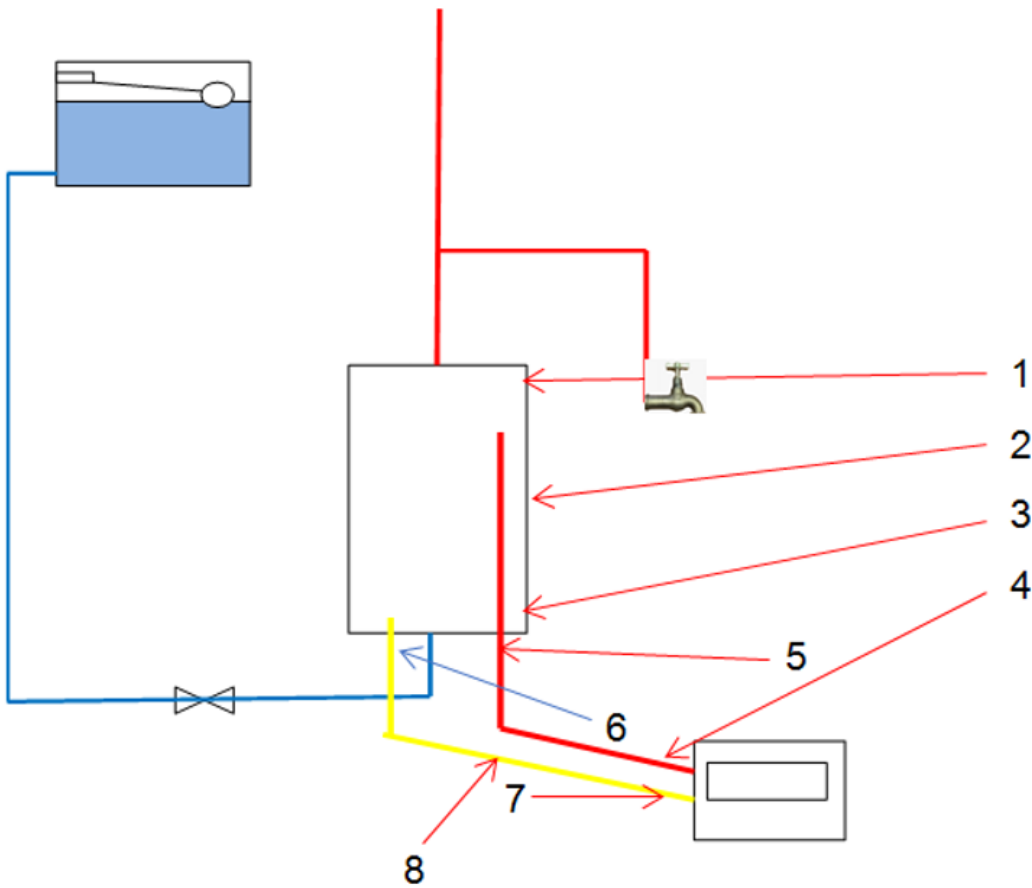

Figure 5. Positions of thermocouple temperature sensors.

This gave us two different measurements. Using the specific heat of water, we could determine fairly closely how much heat had been transferred into the entire volume of water, and by calculating the total energy used by the burner (see above) and subtracting one from the other, we could determine the output of the wetback.

Secondly, a simple comparison of the average temperature rise after a set time would indicate what difference, if any, a new or different configuration made.

TABLE 5. COMPARISON OF THE AVERAGE TEMPERATURE RISE, CONFIGURATIONS 1 AND 2, AFTER A SET TIME.

	Start temperature at three positions on the HWC	Temperature after 5 hours	Average temperature rise
Configuration 1	1. 15°C 2. 13°C 3. 11°C Average 13°C	1. 65°C 2. 60°C 3. 52°C Average 59°C	59 – 13 = 46°C
Configuration 2	1. 12°C 2. 11°C 3. 10°C Average 11°C	1. 66°C 2. 62°C 3. 60°C Average 62.66°C	62.66 – 11 = 51.66°C
In this example, the temperature rise in Configuration 2 was 5.66°C greater than in Configuration 1 – an improvement of 12.3%.			

By placing the sensors where we did, we could also measure, with reasonable accuracy, the speed of the water flow, so if a pocket of water at, say, 90°C passed Sensor 5, we could see how long before it hit Sensor 6, three metres away. If it took 10 seconds, then the water was moving at 3.3 metres a second. By knowing the volume of the pipe (see

above) we could estimate the flow volume.

To calculate the output of the wetback, we first calculated the total energy input to the burner (heater).

Rated input	=	40 MJ/h 6 hours = 240 MJ
Specific heat of water	=	4.2 kJ 180 litres 46°C rise = 34,776 kJ
Which	=	34.776 MJ over 6 hours, or 5.796 MJ/h

There are 3.6 MJ/h in 1 kW, so the input of the wetback in this case is:

$$5.796 / 3.6 = 1.61 \text{ kW}$$

This equates to about 14.49% of the total energy in the firebox being transferred to the water through the wetback.

During early stages of the research, we set the measuring intervals at 30 seconds and ran each test for six hours, believing that would give us sufficient evidence for comparative evaluation. While this certainly enabled many of the initial basic questions to be answered, it also raised a number of others, including the fact that we were seeing unexpected temperature spikes between readings that were not being captured with a 30-second interval.

We also became curious as to whether things might change if we continued heating the water to boiling point; therefore, we changed to 8-hour test cycles and 10-second recording intervals.

The results surprised us, and caused us to repeat some of the earlier tests for the longer duration.

With seven temperature sensors reading at 10-second intervals, we recorded 2,880 data points per hour, or 23,040 over an 8-hour test. These raw data were then imported into Microsoft Excel spreadsheets and converted to graphs. The graphs provide a visual comparison of the numbers, but importantly, also reveal a great deal about the processes at play within each system tested.

In addition to the electronic data, which simply recorded temperature, we also printed forms upon which we recorded the temperature at each point at 15-minute periods. We also noted such things as when noises became audible and when steam or boiling water was expelled. This enabled us to keep a running tab on comparative performance, and after a while we could predict with a degree of accuracy when certain things would happen. These forms have been scanned and are identified as Scanned Forms, and can be viewed by contacting the corresponding author via the publisher.

RESOURCES

A number of organisations and suppliers were very generous in contributing materials and time to our project.

Foremost was Rheem New Zealand Limited, the largest manufacturer and supplier of water heaters in the country, who donated three water heaters for the project. Here is a summary of all donated items:

- A 180-litre low-pressure HWC with 25 mm wetback connections (bottom entry).
- A new (and at that stage unreleased) 180-litre stainless-steel dual-coil mains-pressure HWC. This had coils designed for both a wetback and a solar water heater

to be connected simultaneously.

- A 135-litre low-pressure HWC with 25 mm wetback connections (bottom entry).
- In addition, an Elephant brand mains-pressure indirect HWC, also 180 litres.
- As three of the HWCs were nominally 180 litres, we allowed that a direct comparison between them was reasonable and treated the 135-litre model as a separate case.
- Prior to July 2015, most of our tests were done on 180-litre models with only a couple done on the 135-litre unit, but after July 2015 all our tests were done on the 135-litre unit.
- A commercially available mechanical ‘surge valve’ designed to increase the efficiency of wetbacks, which we had agreed to test for the manufacturer.
- Ten lengths of 25 mm copper pipe donated by Manukau Institute of Technology plumbing department. (This was damaged pipe, having fallen off a truck, and had earlier been donated to MIT for training purposes by a pipe supplier).
- A quantity of 20 mm and 15 mm copper pipe, fittings and consumables, LPG, lagging and numerous items of sundry equipment borrowed or otherwise obtained from Unitec, occasionally by official means.

WATER SUPPLY TO SYSTEM

The building in which the research project was housed was – it has now been demolished – a specially designed training facility for plumbing and gasfitting apprentices at Unitec, and thus had on hand all the tools and equipment required to undertake the work, as well as a ready supply of apprentices for the purpose of heavy lifting when needed. The training facility had at its heart a rainwater capture system, which harvests and recycles rainwater for training systems. We were able to hook into this supply, so when we dumped the water after use we weren’t wasting town water supply.

The facility had a long, high concrete wall upon which we could run pipe, and up which we could fix the vent pipe. There was also a mezzanine that gave ready access to the higher reaches of the system.

We supplied the HWC and wetback systems from a 135-litre supply tank situated directly above the heater, with a measured head of approximately 4.5 m. The reason we used a tank supply rather than the more common valve-fed system was simply to ensure consistency in results. We were not attempting to replicate real-life conditions (though we did as closely as practicable), but to gather data for comparative purposes, which required exactly the same conditions to be applied every time. We felt a supply tank with a known head was best able to provide that consistency.

With the exception of one factor, we do not believe the results would have been any different had we used a pressure-reducing (PR) valve, but if anyone feels that may be the case we would welcome further research on that point. That exception is the fact that as the water heated it expanded, and was able to push back up the supply pipe into the supply tank; a PR valve incorporates a non-return valve and does not allow the water to do that. To replicate this situation, we placed a non-return valve in the supply line at various times and recorded the (comparative) results.

After a number of tests, we found that – depending on the type of HWC or how it was connected, and how hot the water got (length of trial) – some very spectacular

and exciting things happened. This was a combination of loud bangs, crashes, whistles and thuds, accompanied by copious quantities of steam or boiling water being ejected from various orifices when least expected. Later on, we expected them. At one point the entire top of the building filled with steam, setting off the fire alarm and causing the building to be evacuated, and we had to wait outside for the fire service to come and turn the alarm off.

We were instructed by management not to set the alarm off again or they would cancel the research, so we disconnected the alarm, which had the desired effect.

When these events began to happen, we thought it prudent to add to our system certain devices to enable us to measure some of these effects.

These included lengths of transparent plastic tube, expansion chambers, and a number of interlinking (valved and un-valved) pipes to enable the escaping water to be captured and measured. These were held in place by a variety of bits of string, tape and other bits of pipe. It looked a bit Heath Robinson, but it worked. As a result, we had an endless stream of visitors who would drop by, witness the above accompanied by noise and steam, and always ask the same question: "Do you know what you are doing?"

In the end we posted a notice stating the following, which we simply pointed at, and they normally went away:

Stupid question. Of course we don't know what we are doing.
If we knew what we were doing, it wouldn't qualify as research.

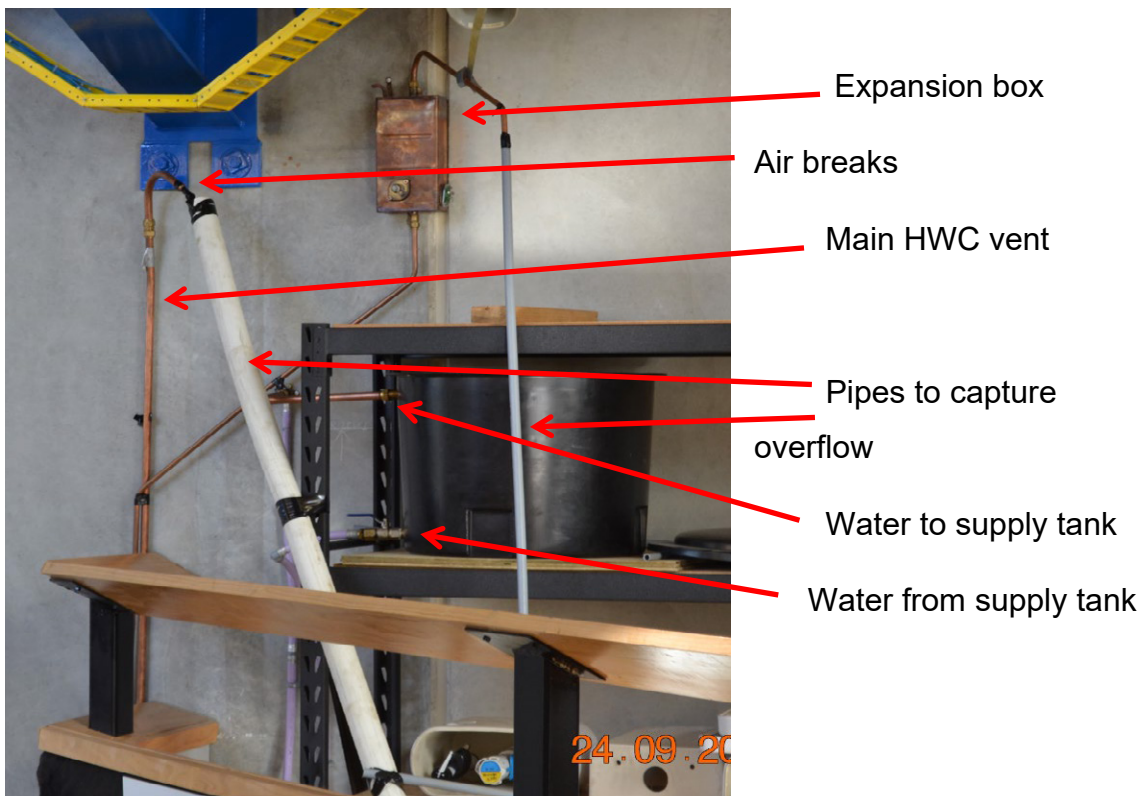

Figure 6. How we measured water expelled during heating cycle.

RESULTS AND FINDINGS

We attempted to undertake the research on a logical basis, by first testing the four wetbacks on a basic adjacent HWC with a minimum rise/fall on the flow and return pipes. By using the same pipework, etc., the only thing changing would be the wetback

itself, so a direct comparison and calculation of output could be made. The data could then be used as a baseline for all future configurations.

Our first set of tests involved connecting the heater to the 180-litre low-pressure (LP) HWC using 25 mm pipes – a basic configuration covered in both compliance documents. A stand was constructed for the firebox to replicate a domestic solid-fuel heater installed on a suspended wooden floor (this was not changed from then on). Another stand, with adjustable height, was constructed for the HWC, which we initially placed at a measured height that provided the flow and return pipes the minimum possible rise and fall. We placed the HWC exactly 1 m from the firebox, so we could use that measurement as a comparative base.

We then heated the water for six hours, taking readings throughout, then emptied the HWC and refilled it with cold water, allowing it to cool down overnight. This procedure was repeated with each of the four wetbacks with 25 mm, then 20 mm pipe.

Later, the HWC was raised and the tests repeated. This enabled us to determine which wetback and which size pipes worked best, and what difference the amount of gradient had on the efficiency of each unit.

Our initial results for this series of tests showed that the advertised or claimed output for the three commercially available wetbacks was inaccurate, and that, as predicted by our earlier calculation of the C number, the Unitec Ladder was most efficient.

Most of our tests for the first year were done from that position; that is, 1-metre distance, using all four HWCs, and a variety of pipe configurations using both direct and indirect heating methods. Later, we moved the HWC further away horizontally, to a distance of 3 metres, and finally to a full 10-metre distance. In both of those cases we conducted tests with both 20 mm and 25 mm pipes, and with gradients ranging from a 150 mm minimum rise, to as much as a 3 m rise.

By these means we were able to determine that a number of 'known' facts and universally accepted principles and beliefs were in fact unfounded.

The following parameters were investigated:

- Efficacy of different model wetbacks.
- Impact of pipe diameter – 25 mm vs 20 mm.
- Gradient of flow and return pipes.
- Differences in performance due to horizontal distance.
- Comparison of direct vs indirect systems
- Two different indirect options:
 - Thermosyphon through the coil vs water supply through the coil.
 - Gradient and configuration of the return pipe.
 - Performance of a heat trap vs surge valve on the return pipe.
 - Counter connection (flow and return connections reversed).
 - Over/under systems using different pipe size and configuration.

During our testing, some of the results seemed to contradict what we had expected based on 'known facts and principles.' These 'known facts' included:

- Both flow and return pipes must rise and fall with a consistent gradient.
- The flow pipe must be connected, or discharge, as close as possible to the top of the HWC.

- Thermosyphon (natural convection) is the motivating force – the thing that makes the water move – for wetback systems.
- NOTE: Thermosyphon results from different water densities brought about by temperature differential.

Our research showed that none of these ‘truths’ are in fact correct, at least in their entirety: in particular, we believe we have proved that in some cases specifically, and in all cases, at latter stages in their heating cycles, a completely different force is at play. This ‘other force’ provides the only explanation for the performance of many less-conventional, but once-popular systems, that do not feature in the compliance documents – i.e., over/under systems.

A small number of other unusual scenarios were also tested, and we will report on those results as well.

We also consulted a number of manufacturers and trade bodies that provided instructions. Most were based on G12/AS1, and some were based on NZS 4603, which are listed under References at the end of this paper. Several of these instructions have simply been copied, and repeat the error of referring to the New Zealand Standard as NZS 6403.

SCENARIO 1. TYPES OF WETBACK.



Box type



Loop type



Ladder (commercial)



Unitec Ladder

Figure 7. Types of wetback.

Brief finding of fact

TABLE 6. COMPARATIVE PERFORMANCE OF WETBACKS.

Wetback type (all 1 m distance)	Test date	Start temperature	End temperature (after 4 hours)	Temperature rise
Loop	08/07/14	14.2°C	48.7°C	34.5°C
Box (stainless steel)	14/07/14	14.9°C	44.7°C	29.8°C
Commercial ladder 08/07/14 15.5°C 68.5°C				53.0°C
Unitec ladder	16/07/14	12.9°C	66.4°C	53.5°C

Conclusion

The output of the wetbacks does not match those advertised by the manufacturer. The worst performing was the stainless-steel box, followed by the loop. The Unitec Ladder using 20 mm headers and 15 mm connecting pipes was the most efficient means of transferring heat, having the highest C number but also using smaller pipe (20 mm), so was cheaper and easier to install.

Because of these factors, and to prevent any accusations of favouring particular manufacturers, we decided to conduct all tests from this point using our own manufactured 'ladder' arrangement, the Unitec Ladder.

The readings were taken after five hours, although the tests continued for longer. The reason is that around this time we started to lose water through the vent pipes, which made useful numbers more difficult to obtain.

NOTE: Not every situation wants or needs the most effective wetback, as energy removed from the combustion chamber reduces the efficiency of the wood burner, which in turn produces more particulates and general pollution. This might reduce the efficiency below the legal limits for that model, so a less efficient model is deliberately chosen to prevent this from happening.

SCENARIO 2. UNDER WHAT CONDITIONS, IF ANY, IS 25MM PIPE BETTER THAN 20MM PIPE?

TABLE 7. EXAMPLES OF COMPARATIVE TESTS.

Major characteristics. Average rise in degrees Celsius.					
Date	Pipe diameter	Distance	Configuration	Special characteristics	Average temp. rise over 5 hours Red = advantage
28/01/15	25 mm	700 mm	Rheem SS conventional mid-coil indirect (180 L)		39.06°C
29/08/14	20 mm	700 mm	Rheem SS conventional mid-coil (180 L)		44.7°C
03/02/15	25 mm	700 mm	Rheem SS counterflow mid-coil (180 L)		41.34°C
09/10/14	20 mm	700 mm	Rheem SS counterflow mid-coil (180 L)		50.9°C
Note: Not only was 20 mm better, counterflow was better than conventional as well.					
13/11/15	25 mm	3 m	Conventional (135 L)	No heat trap, 300 mm rise	76.8°C

28/09/15	20 mm	3 m	Conventional (135 L)	No heat trap, 300 mm rise	78°C*
30/11/15	25 mm	10 m	Conventional (135 L)	500 mm rise	71.4°C
23/11/15	20 mm	10 m	Conventional (135 L)	500 mm rise	72.8°C
10/12/15	25 mm	10 m	Conventional (135 L)	2.4 m rise	62.27°C
14/12/15	20 mm	3 m	Conventional (135 L)	2.4 m rise	65.4°C
*As an experiment we ran a direct comparison with 28/09/15 using 15mm pipe instead of 20mm.					
17/11/15	15 mm	3 m	Conventional (135 L)	No heat trap, 300 mm rise	75.6°C*

*Although we found the 15 mm pipe worked well, we did not continue with testing this size due to personal experience of 15 mm wetback pipes being blocked with mineral deposits from heated water. The risk of blockage outweighed the cost savings, and we do not want to encourage the use of smaller-diameter pipes.

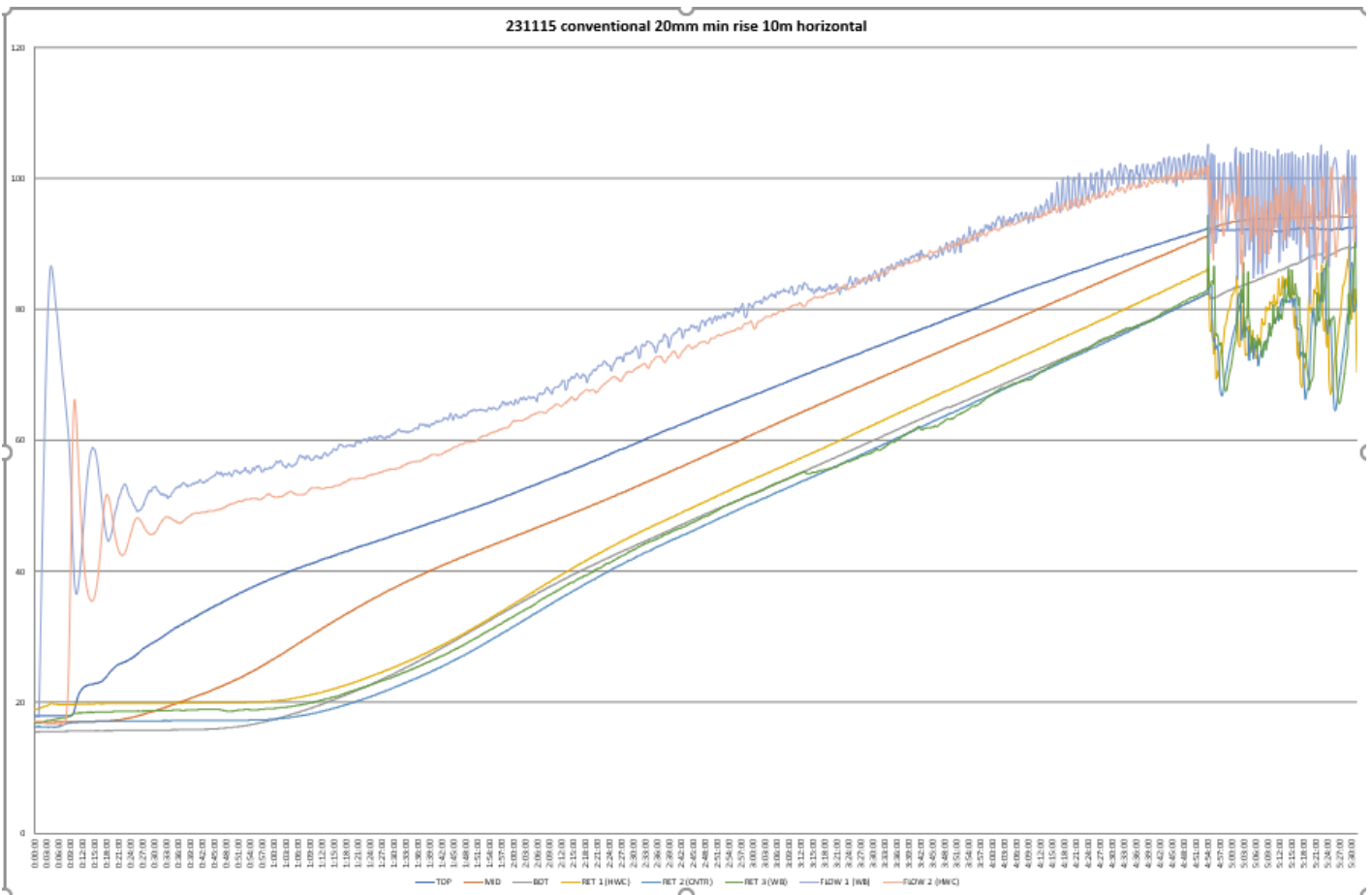

Figure 8. Chart from 23/11/15 using 20 mm pipe.

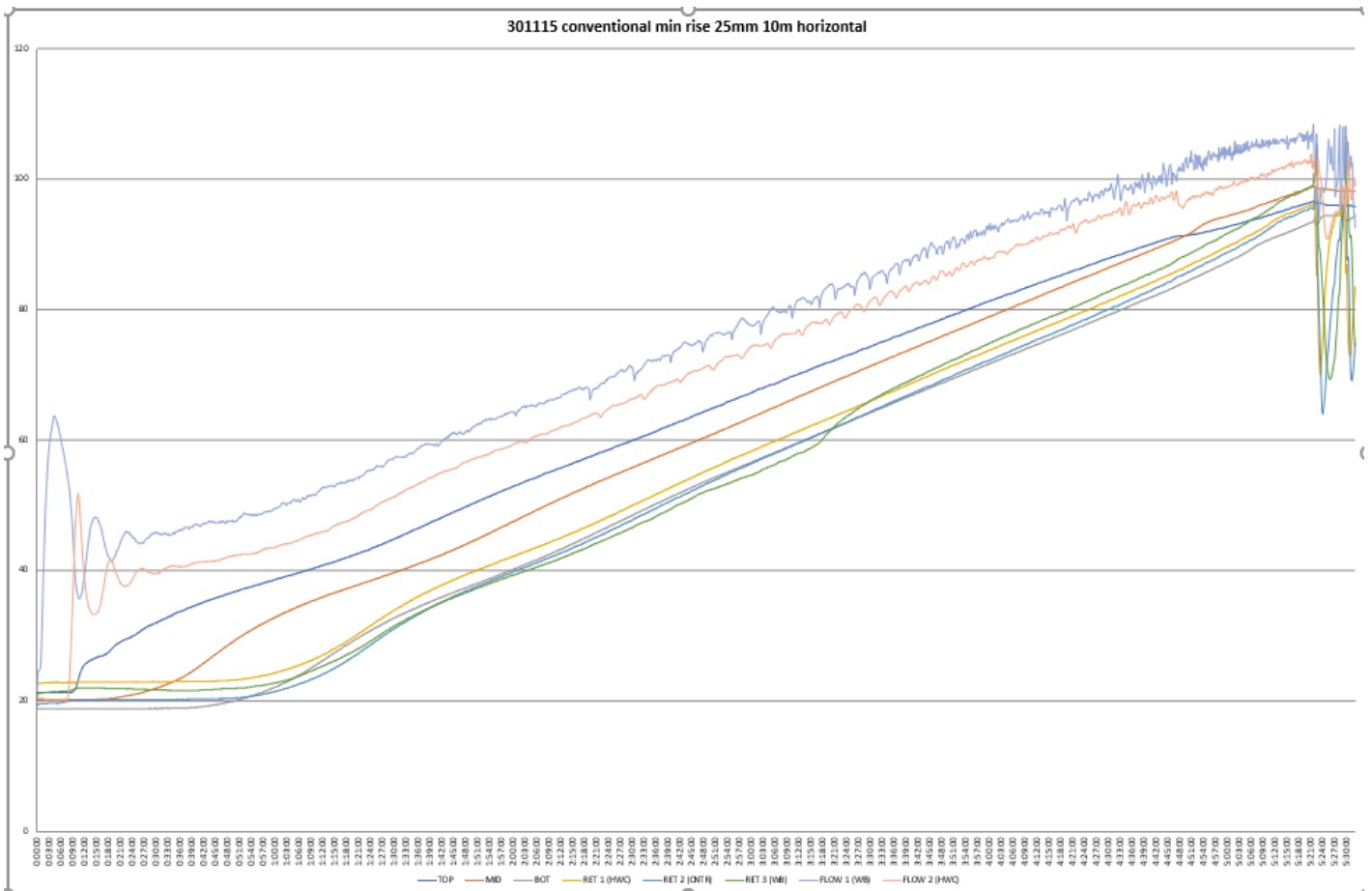

Figure 9. Comparative chart using 25 mm pipe.

Brief finding of fact

No pipe sizes are given in G12/AS1, but in AS/NZS 3500.4 varying pipe sizes are specified depending on the vertical and horizontal distance between the heater and storage vessel. The diameter increases with horizontal distance and decreases with vertical distance from 18 mm (Australian diameter given, which is equivalent to 20 mm in New Zealand) to 32 mm.

We could find no evidence at all that increasing the diameter of the flow and return pipes has any advantage, and in every case the 20 mm pipe resulted in a higher average temperature rise with otherwise identical conditions.

Conclusion

We recommend the optimum diameter of flow and return pipes is 20 mm in all cases.

SCENARIO 3. GIVEN THE DIFFERENT REQUIREMENTS OF G12/AS1 AND AS/NZS 3500.4, ARE THE GRADIENTS SPECIFIED MORE EFFICACIOUS THAN ANY OTHER?

Also, is it necessary to have the same gradient on both flow and return pipes?

TABLE 8. EXAMPLES OF COMPARATIVE TESTS.

Major characteristics. Average rise in degrees Celsius.					
Date	Pipe dia.	Distance	Configuration	Special characteristics (rise or gradient)	Average temp. rise over 5 hours
28/08/14	20 mm	700 mm	Conventional indirect through SS coil	110 mm	43.56°C
12/09/14	20 mm	700 mm	Elephant brand not connected to coil, no heat trap	250 mm	61.8°C
22/09/14	20 mm	750 mm	Elephant brand not connected to coil, heat trap fitted	250 mm	50.1°C
26/09/14	20 mm	700 mm	Elephant brand not connected to coil, heat trap fitted	400 mm	67.9°C
01/07/15	20 mm	900 mm	135 L low-pressure copper. Conventional flow/return with minimum gradient possible	120 mm	84.8°C
21/08/15	20 mm	3 m	Conventional, heat trap	300 mm	77.52°C
07/07/15	20 mm	900 mm	Counterflow	300 mm	85.5°C
29/07/15	20 mm	900 mm	Counterflow	470 mm	79.9°C
31/07/15	20 mm	900 mm	Conventional	470 mm	82.6°C
24/11/15	20 mm	10 m	Conventional with heat trap, return level under floor	500 mm	69.8°C
16/12/15	20 mm	10 m	Conventional with heat trap, return level under floor. Raised to represent 2nd-floor situation	2.4 m	71.6°C

Brief finding of fact

G12/AS1 requires the flow pipe to have a minimum 'upward slope' of 1:20, and an average slope of not less than 1:7. The return pipe is also required to slope at 1:7. There is no specified gradient in AS/NZS 3500.4, but clause 7.2.1 (iii) requires the flow and return pipes to rise or fall in a continuous gradient. We could find no supporting evidence to suggest that any of these figures have any validity.

Conclusion

Only very minimal differences are found between systems with a minimal gradient of 50 mm/10 m (1/200) and gradients as much as 3 m/1 m (3/1). In short, as long as the flow pipe has some sort of rise it will work, and no advantage is apparent for any particular degree of rise. The main reason for temperature differences appears to be related to heat loss rather than gradient.

SCENARIO 4. IS THERE A MAXIMUM OR OPTIMUM DISTANCE AFTER WHICH PERFORMANCE OF A WETBACK SUFFERS, EITHER HORIZONTALLY OR VERTICALLY?

TABLE 9. EXAMPLES OF COMPARATIVE TESTS.

Major characteristics. Average rise in degrees Celsius.					
Date	Pipe dia.	Distance	Configuration	Special characteristics	Average temp. rise over 5 hours
10/07/15	20 mm	900 mm	Counterflow		85.2°C
03/08/15	20 mm	900 mm	Conventional		82.6°C
21/08/15	20 mm	3 m	Conventional		72.5°C
01/12/15	25 mm	10 m	Counterflow	Return level	68.6°C
23/11/15	20 mm	10 m	Conventional	Return level	72.8°C

Brief finding of fact

Although we only tested to a horizontal distance of 10 m, the main reduction in efficiency could be explained by heat loss with conventional lagging. In other words (and certainly within the parameters tested) there is a bigger effect in relation to insulation than to distance. In fact, we believe that as the main motivating force in some cases is steam explosions (see below, Scenarios 5 and 6), not convection (thermosyphon), as previously believed, water may be moved a considerable distance even if all the heat is lost.

Conclusion

Within the 10 m horizontal and 3 m vertical limits of our research set-up, there was little difference in average temperature increase other than heat loss caused by inadequate insulation. It is noted that in some cases the counterflow option gave a greater temperature rise, but not in others. The differences were minor, though, and the other advantages of the counterflow system must be taken into account.

A WORD ON INSULATION (LAGGING)

Throughout this process we used Armaflex, a common industry pipe insulation (known as lagging in the trade) to insulate the pipework. We conducted several tests with the lagging fitted, and repeated the same tests without lagging and compared the difference.

We found that the lagging improved performance by around 10% on average, but also make the point that while this is good, it could be much better. As the water heated up, the outside temperature of the insulation became quite hot to the touch, indicating a considerable heat loss.

A lot of this, we believe, was down to the fact it was a single-layer black product, black being known as a good colour to attract and transfer heat.

We feel that a lot more could be done to improve the characteristics and performance of pipe insulation by using reflective material on the inside and possibly changing the colour as well, and more research would be welcome on this subject.

Good insulation is essential to retaining energy generally – becoming more critical the higher the temperatures, as with wetback flow-pipes in particular, but we were disappointed at how much heat was transferred through this dedicated pipe insulation product.

SCENARIO 5. INDIRECT SYSTEMS. IN TERMS OF EFFICIENCY, IS IT BETTER TO CONNECT THE WETBACK TO THE COIL, OR THE WETBACK TO THE MAIN BODY OF WATER IN THE STORAGE VESSEL, WITH THE COIL USED TO TRANSFER HEAT TO THE CONSUMED WATER?

NOTE: Indirect systems are often specified when it is desired to provide mains-pressure water to the household.

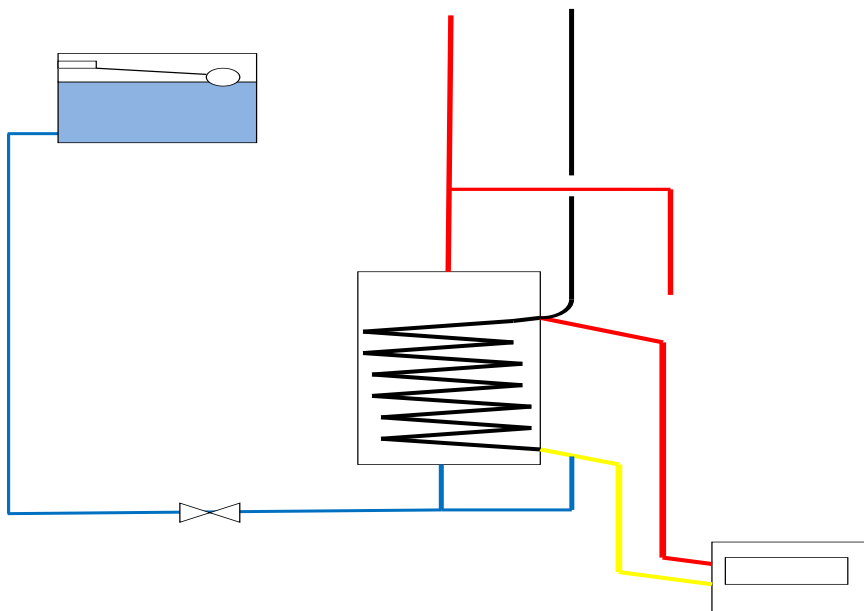

Figure 10. Indirect system with wetback connected to coil (Type 1).

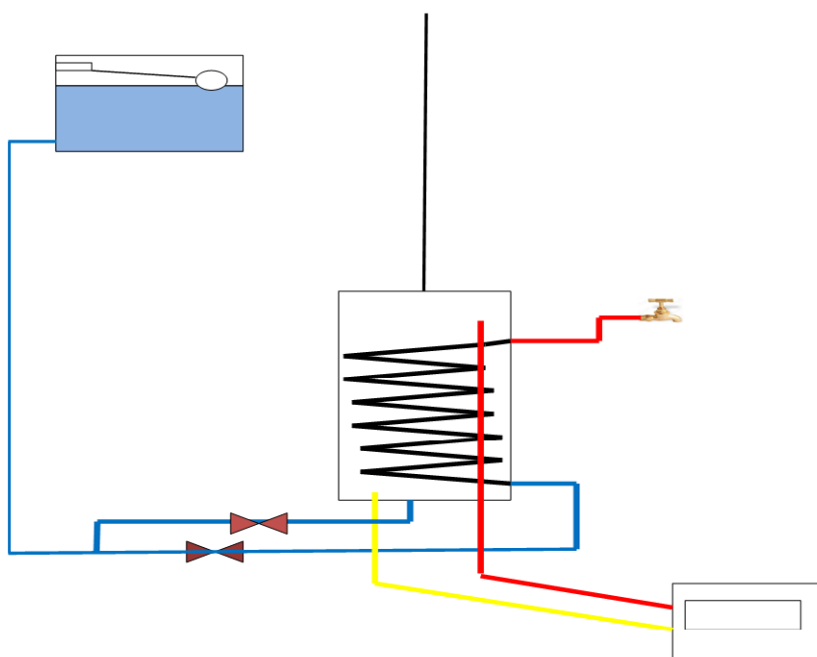

Figure 11. Indirect system with the wetback heating the main body of water, and consumed water heated as it passes through the coil (Type 2).

In the case of mains pressure, the vent pipe on the cylinder is replaced with a temperature/pressure relief valve (TPR).

TABLE 10. EXAMPLES OF COMPARATIVE TESTS.

Major characteristics. Average rise in degrees Celsius.					
Date	Pipe dia.	Distance	Configuration	Special characteristics	Average temp. rise over 5 hours
12/09/14	20 mm	750 mm	Wetback to cylinder (Elephant) (180 L)	Type 2	60.2°C
23/09/14	20 mm	750 mm	Wetback to coil (Elephant) conventional (180 L)	Type 1	51.4°C
24/09/14	20 mm	750 mm	Wetback to coil (Elephant) counterflow (180 L)	Type 1	68.2°C
30/09/14	20 mm	700 mm	Wetback to cylinder (Elephant) counterflow (180 L)	Type 2	65.1°C
01/10/14	20 mm	700 mm	Wetback to cylinder conventional (180 L)	Type 2	65.9°C
21/08/14	20 mm	700 mm	Rheem SS to bottom coil conventional (180 L)	Type 1	
30/01/15	20 mm	700 mm	Rheem SS conventional flow to mid coil (180 L)	Type 1 NB only heating top section of cylinder	38.8°C

The performance of the Elephant system (above) through a coil is reflective of the copper coil extending from the top to the bottom, with over 30 lineal metres of pipe giving a great deal of surface area for heat exchange. However, the performance over a longer period was worse as the heated water reached boiling point and much of it was discharged at a much earlier stage, making this configuration less efficient overall than a direct system.

Brief finding of fact

Type 2 (above) is superior in all respects to Type 1 when taking into account lost surge water and noise. The disadvantages of direct connection of the wetback to the coil are so great that this system cannot be recommended under any circumstances.

Conclusion

Although indirect systems do work, they are less efficient and much noisier than direct systems. Further, they only heat water at or above the level of the coil, and unless the coil runs all the way from the bottom to the top of the cylinder they are very limited in their application. It should be noted that most indirect systems were originally designed to operate with a pumped system (such as with a solar water heater) and have simply been repurposed, with little appreciation of the implications.

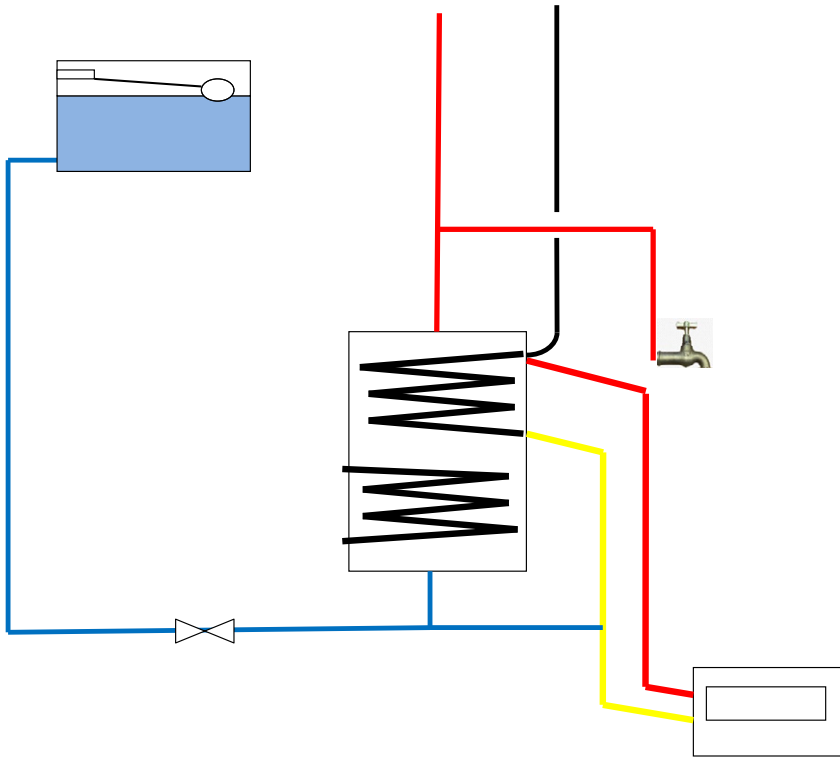

Figure 12. Dual-coil cylinder, one for solar and one for wetback.

The dual-coil cylinder is the worst of all worlds. These are originally designed for pumped systems, and perform very poorly on a thermosyphon. They do work a little, but only in the same way that haggis is food. It disappoints on many levels.

Please note, under Discussion (Theory of water movement within wetback pipes), the significant factor of steam explosions and the thermal and acoustic events created within these pipe systems. The heated water within the coil is a semi-closed system, and thus the water temperature is raised much faster and retained in a confined space, enhancing the effects of the super-heated water.

SCENARIO 6. IS IT NECESSARY OR DESIRABLE TO HAVE RETURN PIPE AT THE SAME GRADIENT AS THE FLOW PIPE?

TABLE 11. EXAMPLES OF COMPARATIVE TESTS.

Major characteristics. Average rise in degrees Celsius.					
Date	Pipe diameter	Distance	Configuration of return pipe	Special characteristics	Average temp. rise over 5 hours Red = advantage
01/07/15	20 mm	900 mm	Conventional (fall) (135 L)	Flow and return 120 mm rise	84.8°C
07/07/15	20 mm	900 mm	Rising return (135 L)	Flow 120 mm rise, return 300 mm rise (counterflow)	85.5°C
28/09/15	20 mm	3 m	Conventional (135 L)	Flow 300 mm rise, return fall no heat trap	78°C
21/08/15	20 mm	3 m	Rising (heat trap) (135 L)	As above, no heat trap	77.5°C

10/12/15	20 mm	10 m	Conventional (135 L)	Flow pipe 2.4 m rise on both flow and return	62.3°C
16/12/15	20 mm	10 m	Level then rising (135 L)	Flow pipe rise, return fall and under floor forming heat trap	71.6°C

Conclusion

No. We can find no evidence to support the requirements in G12/AS1 or AS/NZS 3500.4 that the return pipe must have a specific gradient, and in fact have determined that better results are often obtained with a rising return pipe (that is, the return pipe dropping from the cylinder to a point below the wetback, then rising to the lower wetback connection) rather than it falling: sometimes the difference is significant. In fact, the configuration of the return pipe is largely irrelevant to the operation of the wetback, except as detailed below.

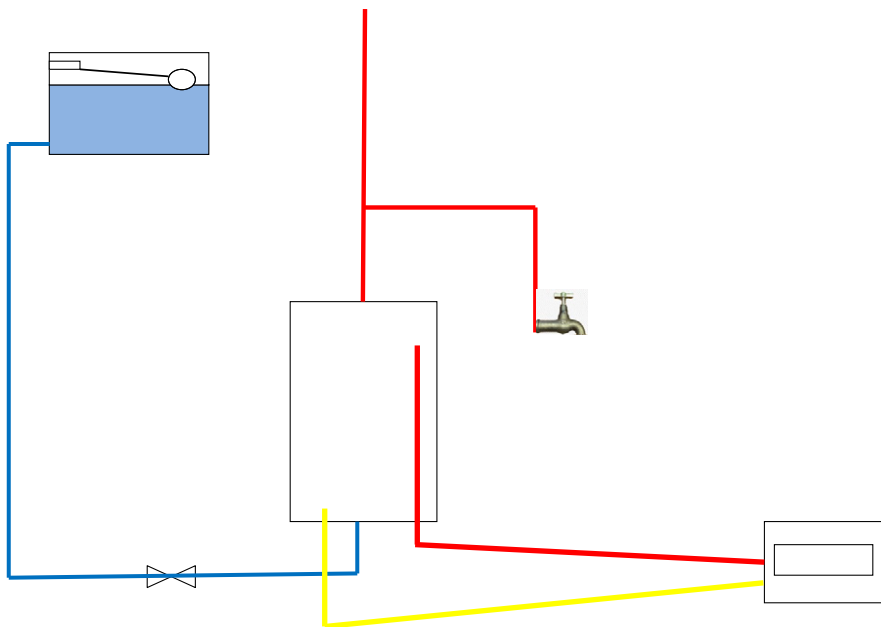

Figure 13. Example of rising return pipe. Gives several advantages, no disadvantages.

Scenario 6: Further conclusion

Having determined that it is not necessary (or even desirable) to have the return pipe falling at the same gradient as the flow pipe rises, and indeed concluding that the exact configuration of the return pipe has little effect on performance, we must consider the requirement for the HWC to be positioned above the heater, or wetback.

Both the approved documents show the HWC positioned above the wetback, and it has always been taught that this is the only acceptable configuration. Certainly, apprentices have always been taught that one reason for this is that if the HWC was at the same level, or below, the wetback, then back-syphonage (or backflow) could occur when the solid-fuel heater is not operating (e.g., during the summer). Back-syphonage would result in heated water from the HWC flowing to the wetback and the wetback

having the cooling effect of a radiator, therefore wasting energy.

We do not believe this is a viable proposition and has no validity as an argument.

The real reason the cylinder is always shown above the heater is because of the requirement to install the return pipe at the same gradient as the flow pipe. If the return pipe is to fall to the heater, then the HWC must be installed above the wetback.

If it is not necessary for the return pipe to fall to the wetback, then the rationale for installing the HWC above the wetback has no foundation.

Certainly in the case of over/under systems (see Scenario 9) the HWC has always been placed on the floor or level with the heater, and the pipe configuration prevents backflow. The same can be achieved with adjacent systems, as shown here.

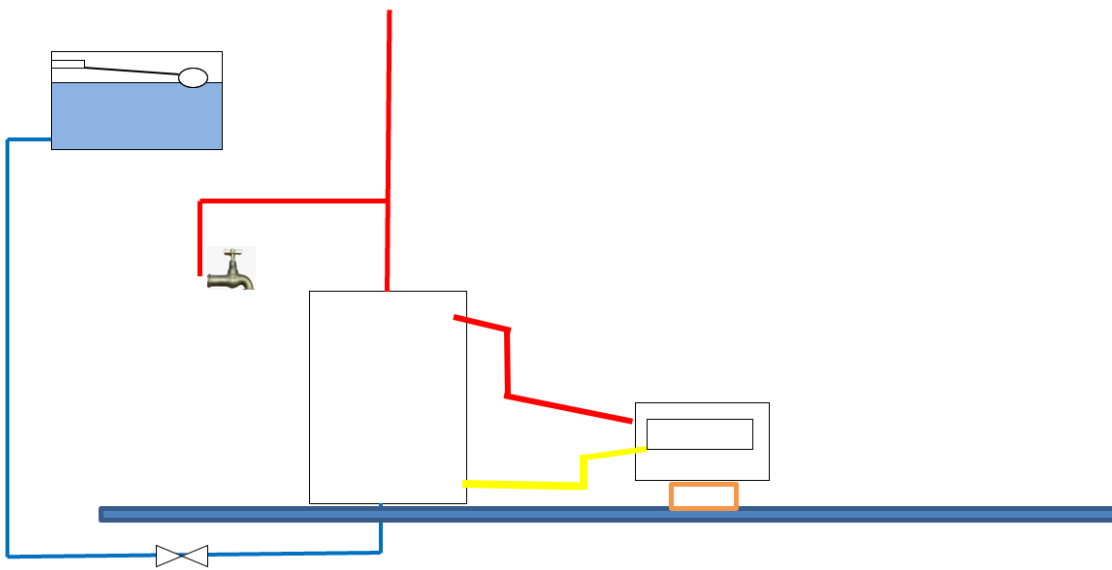

Figure 14. The flow pipe has a rising section that prevents backflow when not in use; the return has a similar heat trap.

The reason we show most of our systems with a raised cylinder is that most HWCs traditionally have bottom entry, but if a cylinder has side entry for the flow and return there is no reason to mount the cylinder above floor level if a conventional flow and return configuration is used.

However, there are often good reasons for raising the cylinder, such as using the space under to fit the valve train, or using a counterflow system (flow pipe to base, return from top) as we recommend, but it is not necessary and when it is not possible to raise the cylinder then there is no need to do so.

SCENARIO 7. DOES A COMMERCIALY AVAILABLE SURGE VALVE HAVE ANY NOTICEABLE EFFECT ON ANY SYSTEM, OR IS THE SAME EFFECT PROVIDED BY A HEAT TRAP?

TABLE 12. EXAMPLES OF COMPARATIVE TESTS.

Major characteristics. Average rise in degrees Celsius.					
Date	Pipe dia.	Distance	Configuration	Special characteristics	Average temp. rise over 3 hours
16/12/15	20 mm	10 m	Conventional flow rising 2.4 m, return dropping under floor level then rising to wetback (135 L)	N/A	42.5°C
17/12/15	20 mm	10 m	Identical to above, but with surge valve (135 L)	N/A	42.3°C
The following tests were conducted on the over/under system at 5 hours.					
18/12/15	20 mm	10 m	Conventional with surge valve (135 L)	N/A	73.3°C
18/01/16	20 mm	10m	As above, no surge valve (135 L)	N/A	68.8°C
19/01/16	20 mm	10 m	Counterflow with no surge valve (135 L)	N/A	67.3°C
20/01/16	20 mm	10 m	Counterflow with surge valve (135 L)	N/A	64.7°C

Brief finding of fact

We conducted a number of tests with identical pipe configurations as detailed in Appendix 3, except with the addition of the surge valve, and found the surge valve made little difference in most cases, with a better result only in one instance.

Conclusion

If the purpose of the surge valve is to prevent backflow of the water, this is readily achieved with a heat trap. Since the valve has to be fitted in the vertical position adjacent to the heater, this section of pipe actually forms a heat trap anyway, and the valve seems to us to be largely redundant.

While anecdotal evidence from some sources claim improvements with the use of such a valve, we consider that the reconfiguration of the pipework necessary to fit the valve (it must be installed vertically) is actually responsible for the improved performance, rather than the valve itself.

SCENARIO 8. COUNTERFLOW. WHAT EFFECT, IF ANY, DOES REVERSING THE FLOW AND RETURN CONNECTIONS FROM THE WETBACK TO THE HWC HAVE ON THE EFFICIENCY OR SAFETY OF THE SYSTEM?

TABLE 13. EXAMPLES OF COMPARATIVE TESTS.

Major characteristics. Average rise in degrees Celsius.					
Date	Pipe dia.	Distance	Configuration	Special characteristics	Average temp. rise over 5 hours Red = advantage
30/01/15	25 mm	700 mm	Conventional (180 L)	Top coil of two, only heated top third of cylinder.	38.3°C
03/02/15	25 mm	700 mm	Counterflow (180 L)	Noted less noise, surge reduced	41.4°C

31/07/15	20 mm	900 mm	Conventional (135 L)	N/A	82.6°C
10/17/15	20 mm	900 mm	Counterflow (135 L)	N/A	85.2°C
10/12/15	20 mm	10 m	Conventional (135 L)	Over/under	62.2°C
19/01/16	20 mm	10 m	Counterflow (135 L)	Over/under	67.3°C

Brief finding of fact

While conventional (flow to top connection) is best for short-term or fast recovery and earliest delivery of warm water, counter-connection (flow to bottom connection) offers significant advantages. These include better long-term efficiency over the entire heating cycle (until boiling), less noise and thermal shock at high temperatures, and less water loss at end-of-cycle discharge. It also promotes 'mixing' and prevents stratification.

Conclusion

Unless fast recovery is a specific desire or requirement, we recommend that the practice of 'conventional' connections be avoided: all flow and return pipes should be reversed, with the flow connected to the bottom and the return taken from the top of the HWC.

SCENARIO 9. AT A STANDARD DISTANCE OF 10 M (HORIZONTAL), COMPARE THE DIFFERENCES BETWEEN A CONVENTIONAL ADJACENT CONFIGURATION AND AN OVER/UNDER CONFIGURATION WITH BOTH 20 MM AND 25 MM PIPE, AND CONVENTIONAL/COUNTER-FLOW CONNECTIONS.

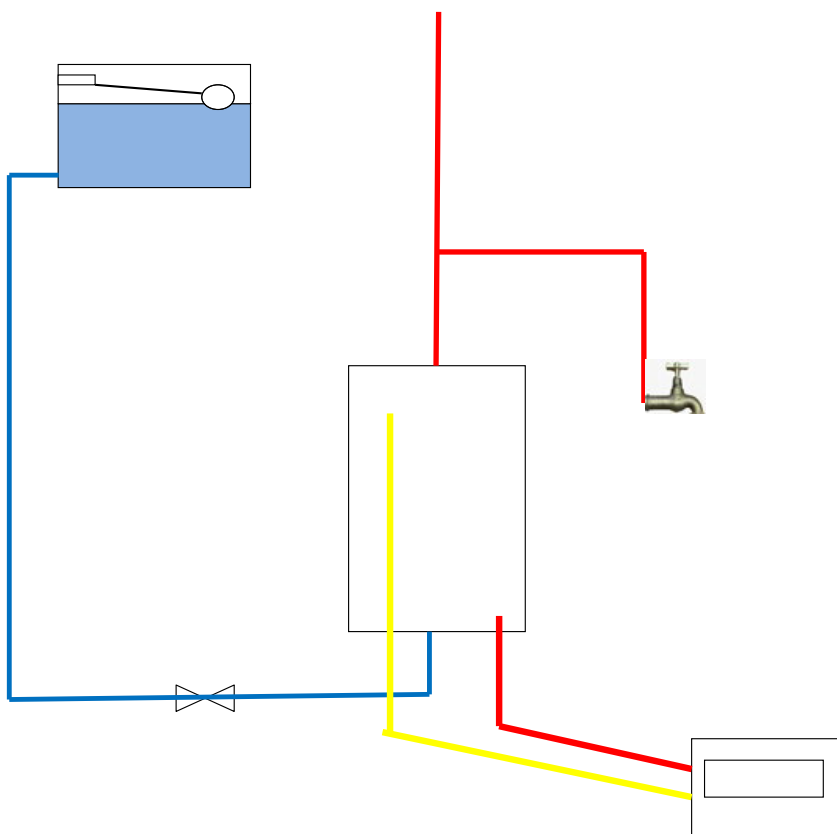

Figure 15. Example of counter-flow connection.

TABLE 14. EXAMPLES OF COMPARATIVE TESTS.

Date	Pipe dia.	Distance	Configuration	Special characteristics	Average temp. rise over 5 hours Red = advantage
24/11/15	20 mm	10 m	Conventional, minimum rise (20mm/m) (135L)	N/A	69.8 °C
10/12/15	25 mm	10 m	Conventional (135L)	N/A	62.2 °C
Over/under systems					
18/01/16	20 mm	10 m	Conventional (135L)	N/A	73.3 °C
19/01/16	20 mm	10 m	Counterflow (135L)	N/A	67.3 °C

Brief finding of fact

There is an improved performance if 20 mm pipe replaces 25 mm pipe; we were unable to establish any situation in which 25 mm provides an advantage. Given the cost difference, we do not recommend 25 mm pipe.

It is not necessary or desirable to raise the HWC above the level of the heater.

Reversing the flow and return connections as above also has advantages in terms of noise, but does not seem to hold the same temperature advantages as an adjacent system.

Conclusion

As long as the flow pipe rises for a short distance (to assist with starting the process), once the water starts to flow (surge) the water movement will continue, and the return pipe can be run level and form a heat trap. While efficiency declines with distance, this is mainly a heat-loss issue mitigated by good insulation.

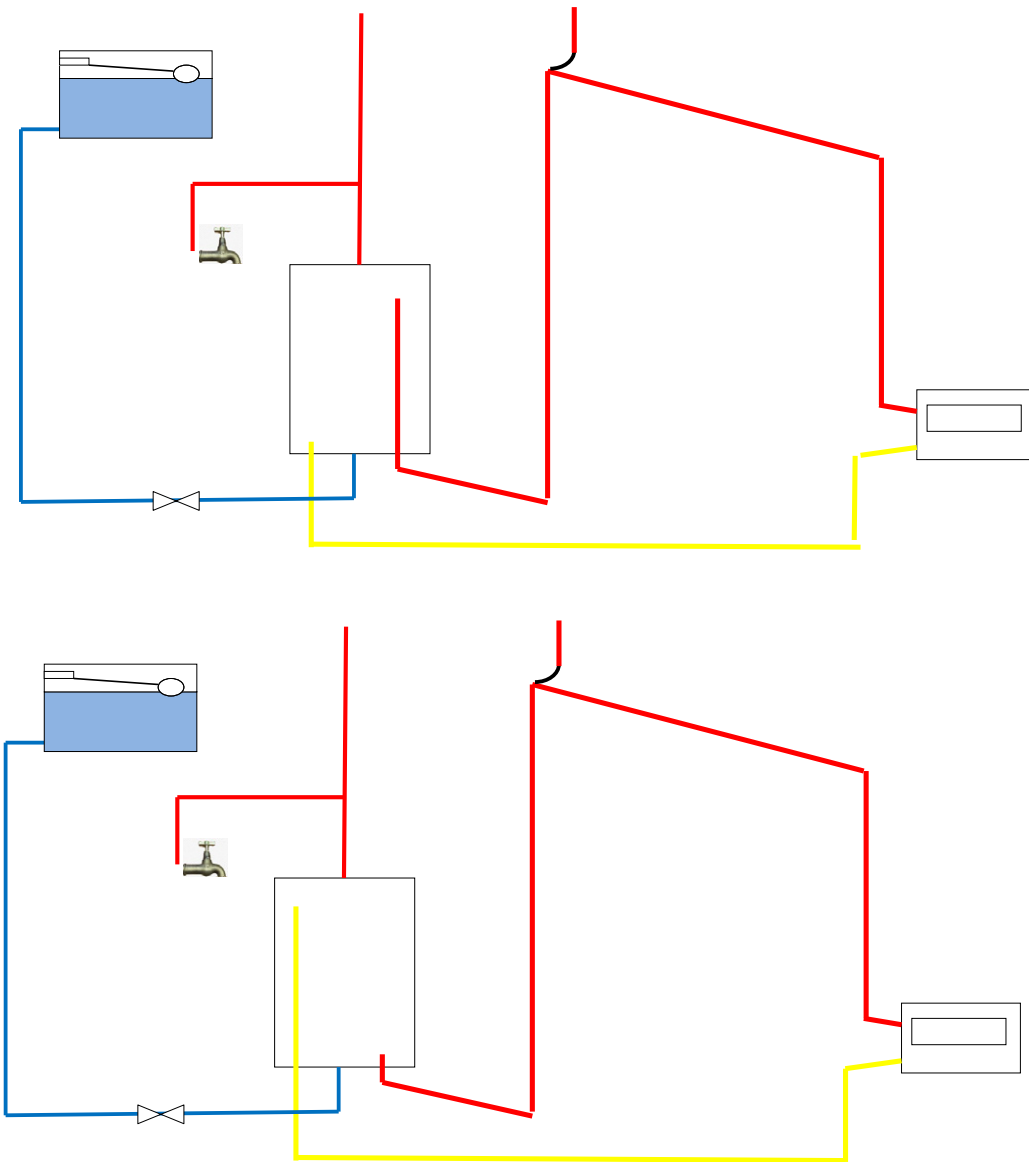

Figure 16. Two over/under systems, the top being conventional and the second being counterflow.

SCENARIO 10. AND THEN WE DID SOMETHING VERY STUPID.

Even before we started this project, when the subject of wetbacks came up there was always someone who would claim that they knew of someone who had installed a wetback with the HWC positioned below the wetback (that is, with the flow and return pipe graded downwards) and it still worked. Nobody ever seemed to have done it themselves.

While we did not believe this to be feasible, we knew that if we did not test this then there would continue to be people who believed it possible, so knew we had to run some tests just to put that hypothesis to bed.

Besides, we had been proved wrong so often over the course of this research project that we had almost given up believing anything and thought, "Hey ho, why not?"

So we set up a cylinder with the base 750 mm below the level of the bottom connection on the gas heater, and conducted a series of tests with several configurations of pipes, valves and vents. We knew we would be creating steam, but

wondered if the pressure generated would be enough to drive water through the system.

We conducted six tests between 05/08/15 and 11/08/15. Full details can be viewed by contacting the corresponding author via the publisher.

Because of the heat trap formed by the vertical drop, there was very little water circulation and, although we tested several different configurations (non-return valves and restrictors to prevent backflow, etc.) the only real success we achieved in actually heating the water in the cylinder was when we placed a vent pipe at the high point and connected it to the normal cylinder vent. This created a further circuit more in line with a conventional system, although there was considerable noise. This only heated the top of the cylinder.

The best we could manage was a rise in water temperature of 37.8°C over five hours, but at the same time the temperature at the wetback outlet reached as high as 189°C after less than an hour.

10	06.08.15 08:52:18									
11	06.08.15 08:52:28	0:52:40	21.4	18.2	14.1	20.3	27.3	107.2	164.2	30.4
12	06.08.15 08:52:38	0:52:50	21.4	18.1	14.1	20.6	28.2	107.6	168.2	33.8
13	06.08.15 08:52:48	0:53:00	21.4	18.1	14.1	20.4	28.2	107.6	171.2	34.5
14	06.08.15 08:52:58	0:53:10	21.4	18.1	14.2	21.7	31.1	107.9	173.8	37.4
15	06.08.15 08:53:08	0:53:20	21.4	18.1	14.2	22.4	32.1	107.9	176.4	36.8
16	06.08.15 08:53:18	0:53:30	21.3	18.1	14.1	20.7	29.5	108	178.2	39.8
17	06.08.15 08:53:28	0:53:40	21.4	18.2	14.2	21.5	31.4	107.8	180.4	38.9
18	06.08.15 08:53:38	0:53:50	21.3	18.3	14.2	20.2	29.3	108.2	182.7	39.1
19	06.08.15 08:53:48	0:54:00	21.3	18.3	14.2	22.3	34.6	108	184	41.8
20	06.08.15 08:53:58	0:54:10	21.3	18.4	14.2	23.9	37.4	108.2	183.4	41.8
21	06.08.15 08:54:08	0:54:20	21.3	18.5	14.2	24.4	37.1	107.9	182.2	41
22	06.08.15 08:54:18	0:54:30	21.2	18.6	14.2	23	34.1	107.4	180.8	36.1
23	06.08.15 08:54:28	0:54:40	21.2	18.7	14.2	21.5	29.7	107.2	179.3	32.3
24	06.08.15 08:54:38	0:54:50	21.1	18.7	14.2	20.1	25	101.5	181	31
25	06.08.15 08:54:48	0:55:00	21.1	18.7	14.2	19.1	21.8	92.7	189.1	28.4
26	06.08.15 08:54:58	0:55:10	21.1	18.5	14.2	18.7	18.4	64.7	189.8	23.9
27		0:55:20	21.1	18.5	14.2	18.5	16.8	48.1	146.2	22.1

Figure 17. Snip of data log record. The three temperatures on the left are the cylinder probes. The second-to-last column is the flow pipe at the heater. It got quite warm.

All the water in the wetback at some point turned to steam and superheated the water, which could not escape (until we fitted a vent); the resulting mixture of thermal and acoustic shocks was spectacular. It is the only time during this research we were actually frightened. The heater, cylinder and all the pipework shook, vibrated and crashed, at times so violently that we stopped the tests and left the building. There was considerable loss of hot water, which surged out of the vent and was lost, replaced by cold water which then repeated the process.



Figure 18. Cylinder below heater level. This test used a vent from the high point of the flow pipe connected to the cylinder vent, which allowed some circulation.

Bearing in mind the threat to call off the research if we had any further evacuations, we had taken the precaution of conducting these tests during a semester break when no apprentices were present, and had rigged up a system to turn off the gas, drain the water and flood the system with cold water quickly, but it still took about five minutes to reach a safe point.

We abandoned the final test with the words recorded on our test sheet: "Water boiled out of W/B at 43 minutes, temp at Sensor 7 at 171°C. Water turned back on, too dangerous to proceed."

Brief finding of fact

We do not believe it possible to safely design a system where the HWC is below the solid-fuel heater. While tests have shown the over/under system is safe and effective with the cylinder at the same level as the solid-fuel heater, this involves a length of pipe first running uphill, which gives the heated water momentum, but other than that situation all flow pipes MUST run at an upward grade at all times. Inadequate venting of the over/under system will result in the creation of quite an effective bomb!

Discussion

GENERAL PRINCIPLES OF A SYPHON

The term 'thermosyphon' implies that the movement of water through the pipes is at least in part due to a syphon being generated. However, the more we thought about it, and the more tests we did, the less the action resembled what we would normally expect of a syphon. A syphon, we assumed, requires a short and a long leg, in a vertical sense, with the weight of water in the long leg pulling the water in the short leg through the pipe, and relying on the cohesive nature of the water molecules to do so.

A thermosyphon has a short and a long leg (always the flow pipe), and we wondered if it would matter if the legs were reversed; that is, if the return pipe was longer than the flow pipe.

It is a generally accepted fact regarding syphons (certainly shown in all the literature we could find) that the inlet tube is shorter than the outlet tube, and that the outlet of the tube must be below the inlet.

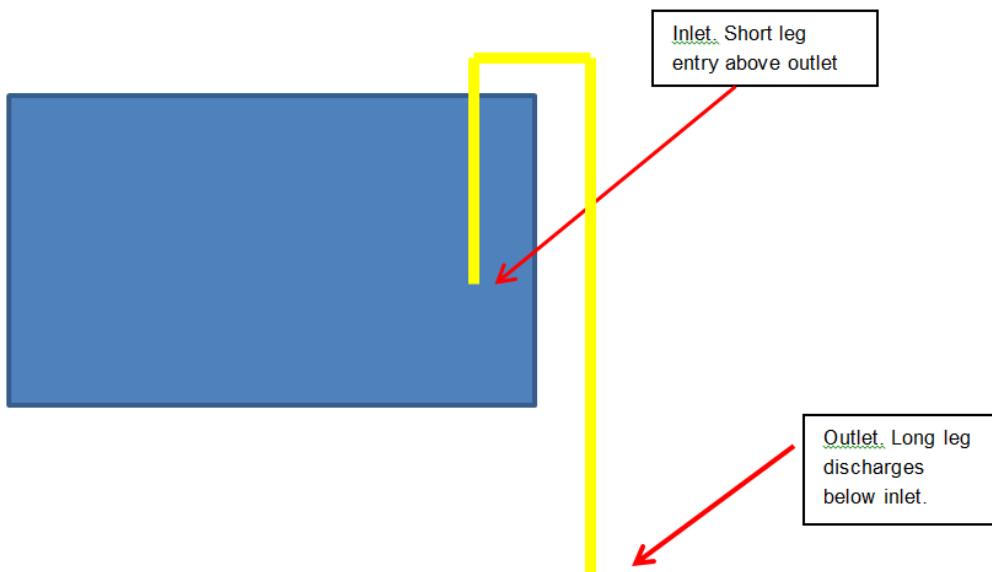

Figure 19. Standard principles of a syphon.

Before trying this out, we decided to see whether we could determine the parameters of a normal syphon, and obtained a 20-metre length of transparent flexible polyethylene pipe. We placed it in a water tank and expelled all the air, replacing it with water. After starting the water flow in the normal way, we adjusted the position of the inlet and outlet, as well as the lengths of the respective legs.

To our surprise, we found that the respective lengths were irrelevant, as were the respective positions of the inlet and outlet; that once a syphon was started, the water would continue to flow from the outlet as long as the outlet was below the surface level of the water in the tank, though was more effective the further below it was positioned. A video of this experiment can be viewed by contacting the corresponding author via the publisher.

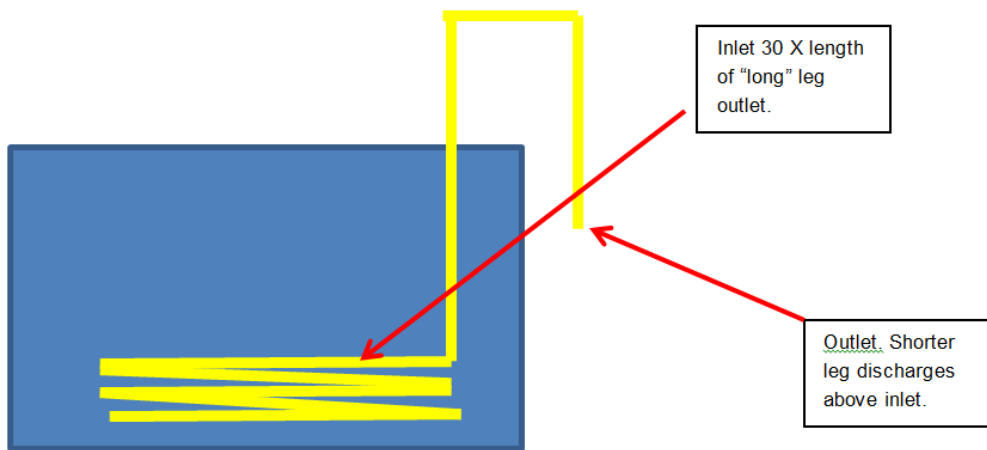

Figure 20. Syphon operated with outlet above inlet and inlet leg 30 times length of outlet leg.

This finding, which seems to contradict all descriptions of the phenomenon known as syphonage we were able to find, invites much more research on the topic, but as far as we were concerned caused us to conclude that designing a thermosyphon around the respective lengths of the flow and return pipes was unnecessary.

In other words, the return pipe could be either longer or shorter than the flow pipe, and it should not make any difference. This means we could connect the flow pipe to the bottom of the HWC, and the return pipe could take water from the top.

STRATIFICATION

The main plumbing textbook in New Zealand has always claimed that if left undisturbed, hot water in an HWC will stratify into layers – hottest at the top, and coldest at the bottom (Doyle, 1988–90b). However, the readings we recorded led us to qualify this to a large extent. We found that if hot water was taken to the top of an HWC it would tend to stay there and not mix, but that if the water was of an equal temperature to start, then it would tend to cool down at an equal rate, without stratification occurring.

This has serious implications for indirect heating systems, as we have shown that in indirect systems, if the coil from the wetback was placed at a high level in the HWC, the water above that would be heated but would not mix at all with the water below the coil. No matter how much energy was expended to heat the water, in a 180-litre cylinder (for example) only about 60 litres may be heated.

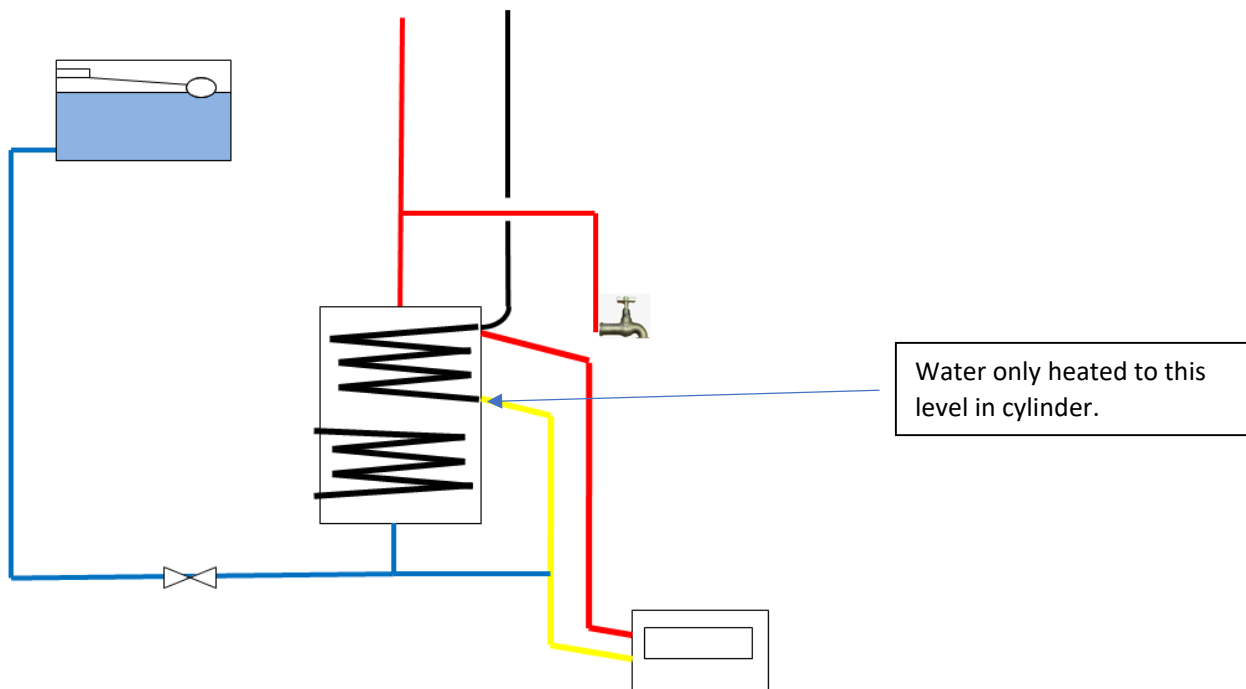

Figure 21. Dual coils causing stratification.

When heating water in the conventional manner, the hot water is returned to the top, and cold water brought from the bottom. We found that when the process started, and throughout the heating cycle, water within the wetback was raised approximately 20°C on average (measured between Sensor 7 and Sensor 4) before there was sufficient change in density to overcome friction, at which time the heated water would surge through the flow pipe to the HWC, to be replaced by cooler water via the return pipe. At no time did the heated water flow in a steady stream, as is implied by the alternate phrase for thermosyphon: 'natural convection.'

This meant that as all the water in the HWC would start out at, say, 12°C and exit the wetback at 32°C, all the water would need to pass through the wetback before the water at the base of the cylinder would rise in temperature. Then as it slowly heated up, water entering the wetback at, say, 30°C would exit at 50°C and be replaced by water at, say, 31°C, and so on.

Because the riser pipe passes through the main body of water, and is made of uninsulated copper, there is some (minimal) heat transfer into that water as the heated water makes its way to the top of the cylinder. However, although the water at the top of the cylinder got hot fairly quickly, it took several hours before water in the bottom third of the cylinder began to heat up significantly.

WATER LOSS AT HIGH TEMPERATURE

In most situations, hot water is used at regular intervals during the day, and fuel use is intermittent, falling to nil overnight. This means that in many cases there is a limit as to how hot the water will get. However, if the input is sufficient and does not diminish, and the draw-off insufficient, the water will reach a temperature at which small spurts of boiling water will be discharged out of the open vent pipe. This is a well-known phenomenon accompanied by much noise in the form of water surging and pipes banging; in the case of our indirect systems, where the coil was connected to the wetback, it was especially alarming.

However, we found that if heat continued to be applied with minimal, or no, draw-off, these discharges became more frequent and involved larger volumes of boiling water, until a tipping point was reached that was both unstoppable and violent. We referred to this on our paper records at the time as the system “losing its lunch.” Between 120 and 150 litres of boiling water would be discharged in one continuous event; this did not stop until all the water in the HWC cooled down.

We discuss the reasons for this fully later in this paper, but as a prequel to that, it is important to understand that the temperature of the water in the cylinder by this time significantly exceeded 100°C.

In the case of our indirect systems, this happened when the top half of the cylinder reached tipping point, even if the bottom half was comparatively cold. In other words, a significant amount of hot water would be discharged over the roof quite early in the process, before the entire HWC was heated. This is a very significant loss of energy, and water. See videos by contacting the corresponding author via the publisher.

COUNTERFLOW SYSTEM

We therefore made the decision to undertake a single test to find out what would happen if we ignored all the rules and reversed the connections of the flow and return pipes at the cylinder end. We were not sure it would work, and it was so counter to the accepted principles and rules that we made the mistake of expecting a poor result. In fact, so sure were we that this was a dead-end experiment, we named it *The Bastard System*, as we were sure no one would want to claim parentage of it. If you look at the scanned paper records, available by contacting the corresponding author via the publisher, you will note which tests were conducted like this, as they are identified with the word ‘Bastard.’

There were three main results.

1. As the water entered the HWC, instead of rising to the top through the riser pipe, the heated water hit the main body of cold water and dissipated as it rose. This had the effect of warming the entire body of water, top to bottom, at a reasonably even and steady rate.
2. The temperature at the top of the HWC (measured at Sensor 1) rose at a much slower rate, though it did rise. However, as this water was where the return water came from, water then entered the wetback (Sensor 4) at higher temperatures much sooner, and increased this higher temperature by 20°C. This meant that water was returned to the HWC at a much higher temperature much sooner, increasing the *average* temperature much faster.
3. There was virtually no noise (at least on the direct systems) until the very end, indicating a much smoother and less restricted water flow.

When the inevitable high-temperature surge and loss of water did happen, it did not do so until much later in the cycle, when all of the water had reached tipping point. As it is likely that, under normal household use, some water would have been drawn off during this time, we feel that water loss under these circumstances is likely to be less common. As less energy was used overall, we determined that the long-term effect made this system more efficient than the conventional one.

These advantages were found to apply to every subsequent scenario in which we reversed the connections. There was no scenario in which a conventional system was more efficient, though the conventional system (also known as a quick-recovery system)

had the advantage of enabling hot water to be drawn much sooner during the initial heating phase. However, this advantage was short lived, and a time always came when the temperature at Sensor 1 'crossed over,' so to speak, and the counterflow method then outperformed the conventional in every way. In short, then, taking the long-term view over an entire cycle, we found the counterflow ('Bastard') system to be more efficient and better performing than the conventional configuration required by both G12/AS1. NZS 4603 and AS/NZS 3500.4.

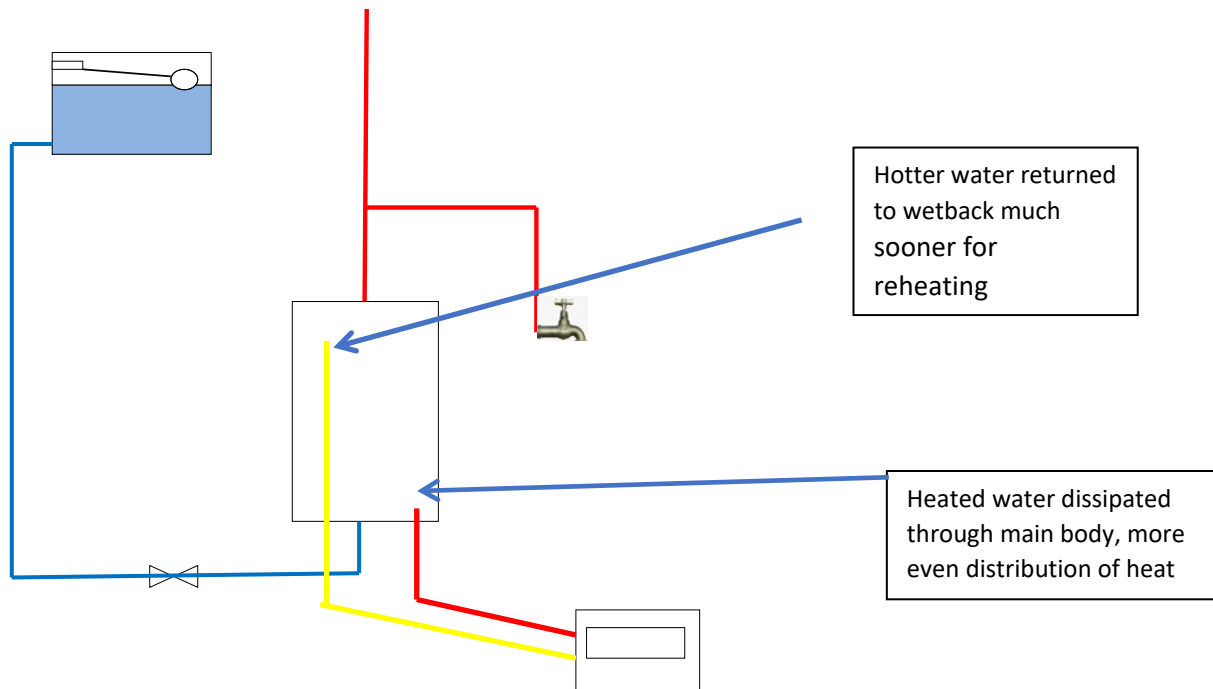

Figure 22. Counterflow system.

CONFIGURATION OF RETURN PIPE

AS/NZS 3500.4 requires the flow and return pipes to rise and fall at a continuous gradient. G12/AS1 stipulates the return pipe must fall at a specific gradient of 1:7, or 142 mm per metre, the same as the average upward slope of the flow pipe. We wrote to MBIE and asked them where they got these gradients from, but received no reply.

We noticed an interesting effect on all our early tests after we placed a sensor in the middle of the return pipe, at position 8 in the figure below.

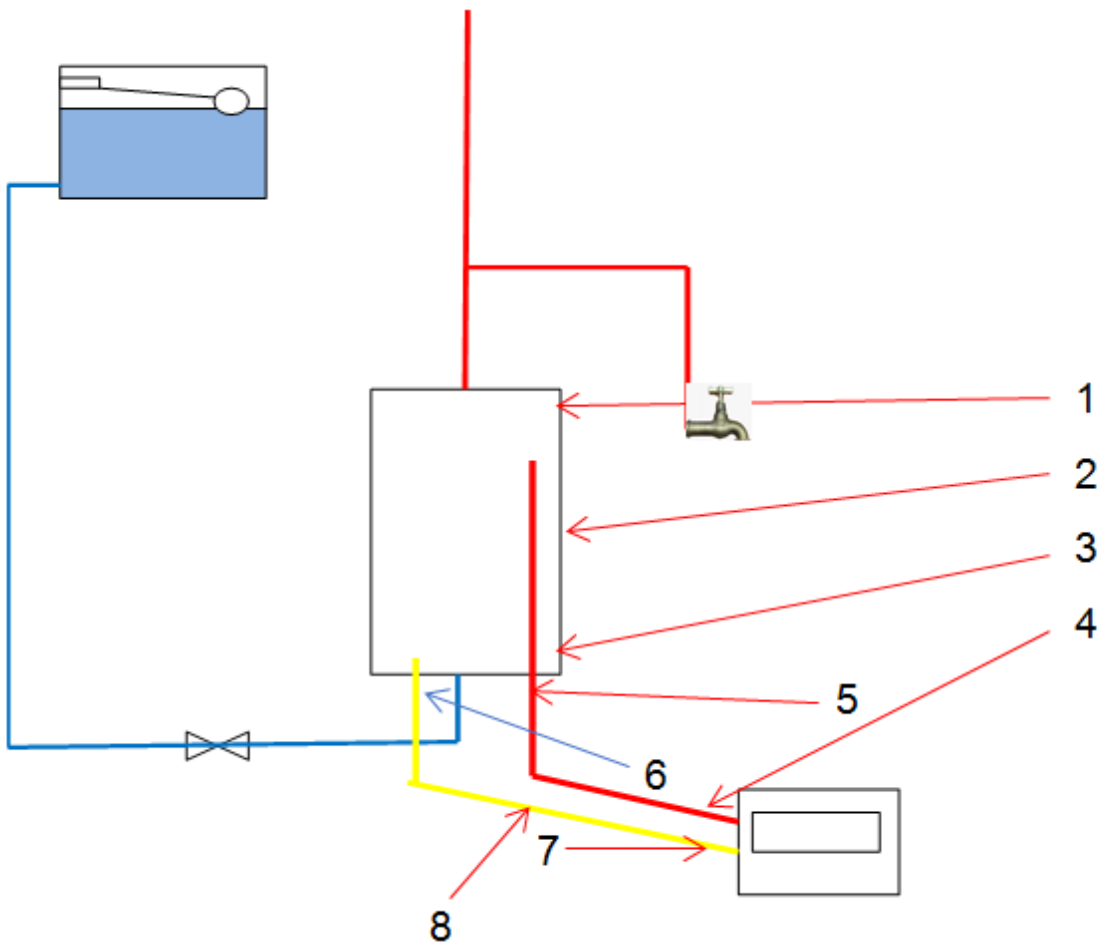

Figure 23. Position of thermocouples, all tests.

We found that as the combustion chamber reached temperature and water began to surge through the flow pipe, there was also a small temperature increase at positions 7 and 8, more so at position 7. We were expecting this at position 7, just due to conduction through the copper pipe. However, we were a bit puzzled by the temperature rise at 8. We hypothesised that water was stupid, did not know which pipe was which, and would take the line of least resistance.

Once the water started to flow, it would only go in one direction, but before then the water would need to get hot enough (contain enough energy) to overcome the resistance of the pipe as well as the resistance of the mass of water. During this phase, some of the heating and expanding water at the bottom of the wetback would attempt to rise up the return pipe, against the desired direction of flow – after all, not only is the return pipe falling from the HWC, it is in fact also rising from the wetback – albeit from the bottom of the wetback.

So we asked ourselves what would happen if the return pipe, instead of falling towards the wetback, did the opposite, and rose towards it? This would prevent the propensity of water to rise upwards through it when heated, but would it also have some unknown negative effect?

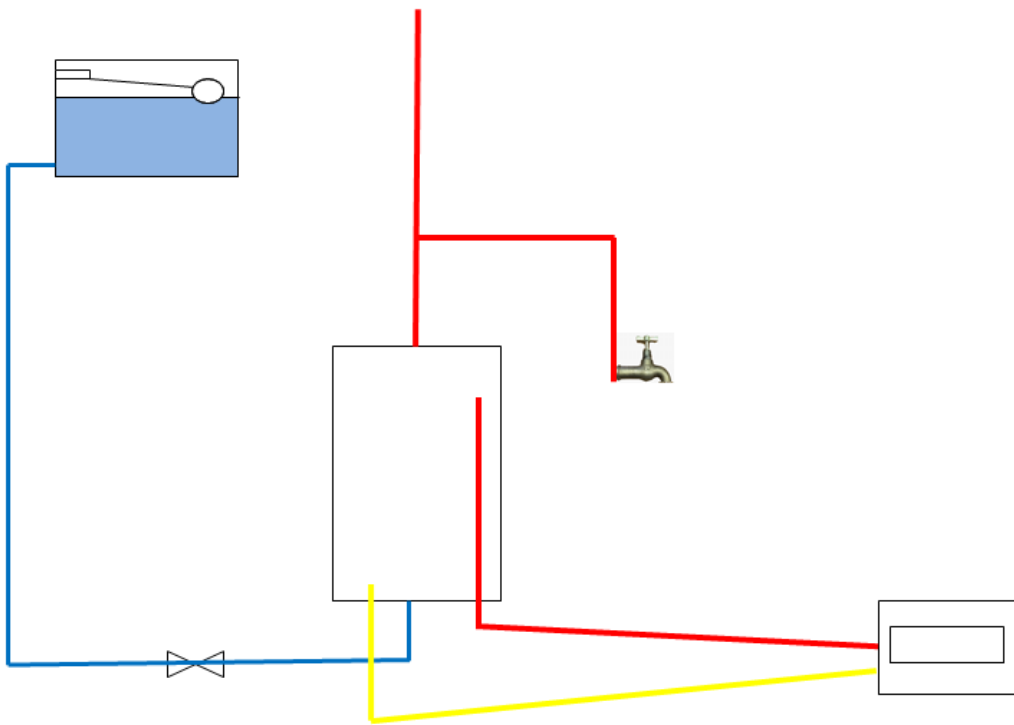

Figure 24. Return pipe rising towards wetback.

The first test, of what we referred to as a 'rising return,' was done with 25 mm pipes at a horizontal distance of 1.0 m. We were very surprised by the result – to the extent that we thought there was a mistake. Therefore, we repeated both the previous conventional test, and then, again, the configuration with a rising return as shown in Figure 24. The result was the same – the rising return alone delivered a 23% increase in efficiency.

Subsequent tests with 20 mm and 25 mm diameter pipes, at 3.0 m and 10.0 m distances, with several different HWCs (both direct and indirect) confirmed that in every case, a rising return was more efficient, though only between 5% and 10% on average.

The explanation is obvious in retrospect: because the pipe was directed downwards from the wetback, and hot water has a tendency to rise (it is less dense and therefore more buoyant), there was no tendency for the heat to pass to the return pipe except a very small amount by conduction. This, after all, is the principle of a heat trap.

That then led us to the next question: if all we are doing here is forming a heat trap (common, and in fact required on some water heaters), then if there was no room to get the pipe to rise, could we get the same effect by fitting a purpose-made heat trap? So we made a couple, one 25 mm, and one 20 mm diameter, and tested them under a variety of situations, as seen in Figure 25.

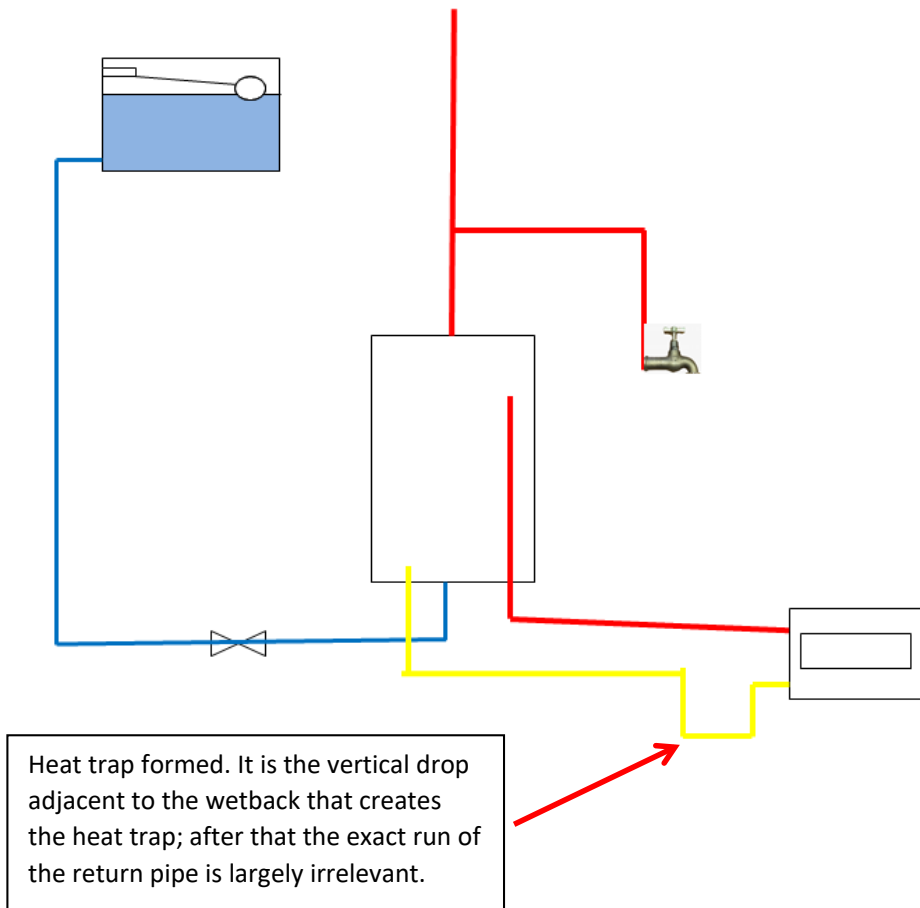

Figure 25. Heat-trap tests.

We can report unequivocally that the requirement for the return pipe to *fall*, either at the same gradient as the flow pipe, or even just a consistent amount, cannot be justified.

For practical reasons, it may be common to run the return pipe under the floor of a building, and our research showed quite clearly that this could be done level, or with either an upwards or downwards gradient, or even a combination. It really made no difference, except that the conventional falling option as required in G12/AS1 and AS/NZS 3500.4 is the worst-performing configuration in all cases. Obviously, if water rises through the flow pipe a vacuum will not occur in the system, the water will be replaced by an equal volume of water through the return pipe, irrespective of that pipe's configuration.

Our preference is to have the return pipe fall vertically from the HWC, run level, then rise vertically by at least 150mm before entering the bottom of the wetback.

Note: the tests done involving a commercially available surge valve are reported separately.

FULL OF SOUND AND FURY, SIGNIFYING NOTHING

Except it is not nothing. As reported earlier, all wetback systems generate noise at some stage in their heating cycle, some a lot more than others, and some a lot earlier than others. At very least there is a mild background whooshing noise of surging water, at worst there can be a crashing and banging of pipes that causes the structure of the house to vibrate. The worst noises in our study, clearly audible at 15 metres in an open workshop, were generated in indirect systems with the wetback connecting to a



Figure 26. Stainless-steel indirect HWC, two coils.

coil. And the worst of those were the stainless-steel models with a stainless-steel coil, versions of which are now marketed by several manufacturers or importers.

Next down in the alarming noise category is any over/under system, where the sound of water surging through the pipe at regular intervals is an expected effect.

We recorded a variety of these hot-water inspired musical interludes, and they can be accessed by contacting the corresponding author via the publisher.

So what causes these noises? It is clearly not just water flowing through pipes, nor is it water hammer, because the water does not reach the velocity required to produce water hammer, nor does it stop suddenly.

Analysis of the data from several tests led us to formulate a theory, which also explains how it is that water can be made to flow through an over/under system for very long distances – clearly not a function of a thermosyphon. Simple convection would not seem to us to explain movement of the quantity of water at the speed involved.

Theory of water movement within wetback pipes

There are a number of matters of definition that must be clarified. Firstly, there is a difference between convection and thermosyphon, though the two are often confused.

Convection is the process whereby a fluid (gas or liquid) will move within its own volume when heavier fluids displace and move lighter fluids, pushing them upwards. The process is driven by the difference in density, and is a function of temperature difference, the whole system driven by the force of gravity.

A thermosyphon relies on the same principles of density difference, but involves two different vessels connected by pipes. One of the vessels is a storage container, the HWC, the other, the wetback – smaller and subjected to a heat source that is used to transfer heat to the water within.

As the liquid in the wetback is heated, the density difference will begin a process whereby the heavier (colder) liquid in the storage tank displaces the less dense liquid, normally hot water. As the two are connected by pipes, the less dense water is pushed up the higher pipe by the more dense, colder water coming into the lower pipe. This natural process is driven by gravity.

The difference between the two events is that in the self-contained system there is effectively no resistance or friction involved in the process apart from that of the fluid itself. With a thermosyphon, however, other forces come into play: primarily friction, where the water contacts the walls of the pipes and fittings used to convey it; and to a lesser extent, turbulence, especially at bends and joins. It is this process of effectively forcing water through a constricted passage that we call a thermosyphon.

This may seem obvious, but pipe diameter, length and pipe material all add friction to various degrees, and all contribute to a natural resistance in the process, along with the total mass (volume) of water being moved. This friction must be overcome before any circulation can take place. Reducing the amount of friction to a minimum therefore will aid the process, while too much resistance will prevent easy circulation.

It is self-evident, and confirmed by empirical evidence, that a simple connection with straight pipes, with immediately adjacent components, is the most effective system. This is an **adjacent direct** system. When this is used, it has been found that the temperature difference between the flow and return pipes averages about 20°C; that is, the water is raised in temperature by about that much on a more or less continual basis, with some minor irregularities (surging) depending on a number of factors. The temperature of the water in the wetback itself does not reach very high temperatures until that in the main storage system rises, and will take many hours to reach temperatures exceeding 100 °C.

It is important to note here that the temperature (initially at least) remains fairly low because the water is more or less continually circulating, as it does not sit for long in the wetback.

However, the opposite is the case when the water does sit for periods without significant movement. In that case, the water can reach much higher temperatures, and this has a very significant effect on how the water behaves within the system.

To understand this effect, a basic principle of physics (or plumbing, as it is sometimes called) must be understood, and that concerns the relationship between pressure and the boiling point of water. Most people can tell you that the boiling point of water is 100°C, but usually fail to complete that statement with *at atmospheric pressure* – at sea level. The boiling point of water actually differs depending on what

pressure it is subject to, rising and falling with pressure. Water under pressure will absorb more energy and thus boil at a higher temperature – with an uncontrolled heat source this has a major impact.

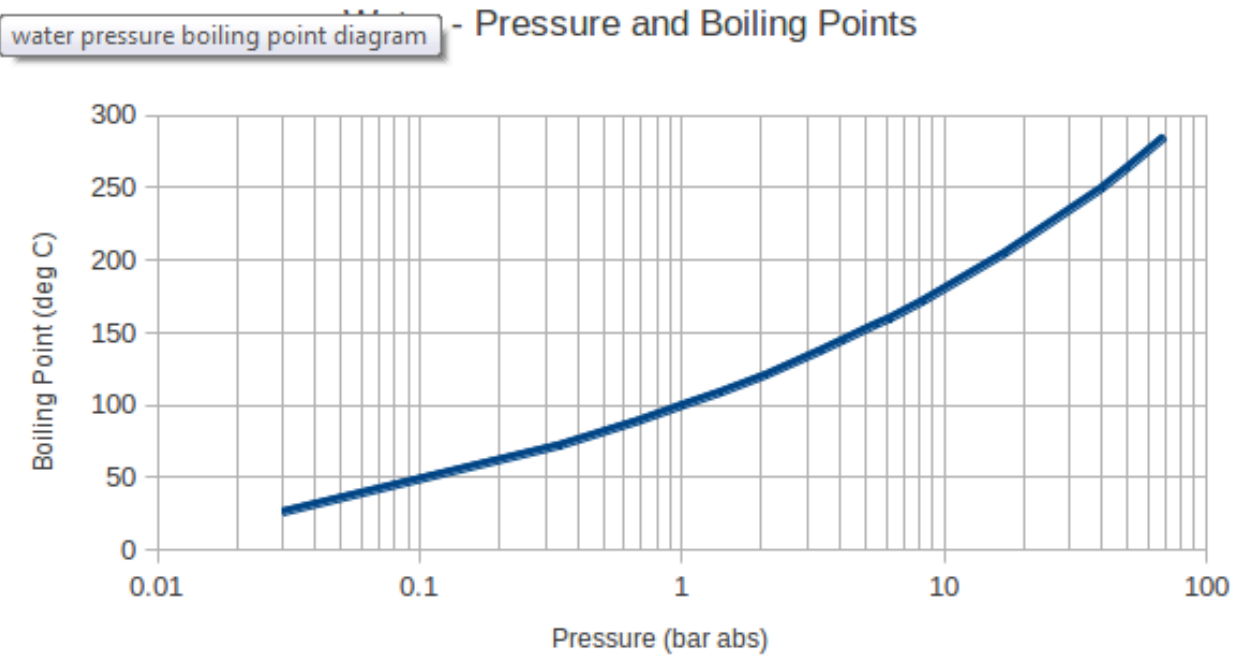

Figure 27. Water pressure and boiling points. Source: <https://www.engineeringtoolbox.com/>

It should be noted that the relationship shown is not linear, with the boiling point rising on an increasingly steep curve. In Figure 28, it can be seen that water boils at 100°C at about 1 bar – that is, atmospheric pressure at sea level.

Water – Pressure and Boiling Point

Pressure			Boiling Point	
psi	kPa	bar	deg F	deg C
0.5	3.45	0.034	79.6	26.4
1	6.90	0.069	102	38.7
2	13.79	0.138	126	52.2
3	20.69	0.207	141	60.8
4	27.58	0.276	153	67.2
5	34.48	0.345	162	72.3
6	41.37	0.414	170	76.7
7	48.27	0.483	177	80.4
8	55.16	0.552	183	83.8
9	62.06	0.621	188	86.8
10	68.95	0.689	193	89.6
11	75.85	0.758	198	92.1
12	82.74	0.827	202	94.4
13	89.64	0.896	206	96.6
14	96.53	0.965	210	98.7
14.69	101.3	1.01	212	100
15	103.4	1.03	213	101
16	110.3	1.10	216	102
17	117.2	1.17	219	104
18	124.1	1.24	222	106
19	131.0	1.31	225	107
20	137.9	1.38	228	109
22	151.7	1.52	233	112
24	165.5	1.65	238	114
26	179.3	1.79	242	117
28	193.1	1.93	246	119
30	206.9	2.07	250	121
32	220.6	2.21	254	123
34	234.4	2.34	258	125
36	248.2	2.48	261	127
38	262.0	2.62	264	129
40	275.8	2.76	267	131
42	289.6	2.90	270	132
44	303.4	3.03	273	134
46	317.2	3.17	276	135
48	331.0	3.31	279	137
50	344.8	3.45	281	138
52	358.5	3.59	284	140
54	372.3	3.72	286	141
56	386.1	3.86	288	142
58	399.9	4.00	291	144
60	413.7	4.14	293	145
62	427.5	4.27	295	146
64	441.3	4.41	297	147
66	455.1	4.55	299	148
68	468.9	4.69	301	149
70	482.7	4.83	303	151

Figure 28. Boiling point of water (absolute pressure).

Source: <https://www.engineeringtoolbox.com/>

Between atmospheric pressure and a head of 9.3 metres (193.1 kPa) the boiling point increases by 21°C, or an average of 0.446°C per metre. Taken between atmospheric pressure (101.325 kPa absolute) and a head of 39 metres, the boiling point increases by 51°C, an average of 0.76°C per metre.

More importantly for our purposes is the difference in boiling point between a 3-metre head and a 5-metre head (131 kPa and 151 kPa). That 2-metre difference accounts for a difference of 5°C, or 2.5°C per metre, 107–112°C. In fact, for the first 10 metres of head, an average of 2°C per metre is added to the boiling point.

All wetback systems must be open vented to prevent temperatures and pressure getting too high. If water at 100°C is dangerous, water at 150°C is even more so, as when it is released and exposed to atmospheric pressure it will instantly turn to superheated steam, which has obvious and serious safety implications.

However, all plumbing systems are subject to some pressure, and open-vented low-pressure systems are no exception. A typical system will have at least 3.6 metres head of water (36 kPa), with a common pressure-reducing-valve setting of 7.6 m (76

kPa) producing a potential boiling point of around 115°C at the base of the system (see Figure 24).

When a thermosyphon system is designed in such a way that initial water movement is prevented or restricted by excessive resistance, the water is held in the wetback long enough to raise the water temperature to, say, 112°C if subject to a head of 5 metres. In fact, water will reach that temperature in any system with an uncontrolled heat source if subjected to that pressure.

There are two systems that are prone to doing this: an indirect system utilising a coil-type heat exchanger within the main storage tank; and an over/under system, which has a very long length of pipe in both the flow and return legs, and a flow pipe that falls before entering the storage vessel.

Eventually the pressure difference will overcome the resistance within the system, and some of the water will be forced up the flow pipe towards the storage cylinder. If the connection to the cylinder is, say, 1 metre higher than the wetback connection, the boiling point at that position will be 2°C less than at the wetback.

When a comparatively small quantity of water at, say, 115°C is suddenly exposed to a lower pressure where the boiling point is, say, 113°C, then that superheated water instantly boils, with some flashing to steam.

It should be noted that not all the boiling water will turn to steam, in the same way that not all water in a kettle will turn instantly to steam just because the water is boiling. It takes a lot more energy to change water to steam than it does to raise the temperature of the water (latent heat principle), but some will.

When water turns to steam it expands by approximately 1,700 times its original volume. It will not remain as steam for long, as when the steam mixes with the colder water (even if some of that water is over 100°C), it will condense and revert to (liquid) water again.

In the meantime, however, this sudden expansion in volume exerts a considerable pressure on the surrounding water, pushing it away in a surge, and taking the line of least resistance. If the system is fed by a supply tank with no non-return valves between the tank and the wetback system, much of that water flow will be pushed back into the cold-water supply side, some will in fact be forced through the thermosyphon system (through the coil or up the flow pipe in the over/under system) and, depending on a number of factors, some may be forced up the vent pipe and discharge over the roof.

The hot water thus lost from the system is then replaced by cold water, which has a sudden chilling effect on the circulating system. The water in the wetback then reheats and the process is repeated.

In the event that the system is fed by a pressure-reducing valve or otherwise has a non-return valve in the system, the surge is unable to go back that way, and the surge of water is forced, in many cases, up and out of the vent pipe. This water is boiling hot, having been heated initially directly by the wetback, but also by the burst of superheated steam created when the extra-hot water was exposed to the lower pressure.

It is this steam explosion that is the main motivating force of water flow through wetback flow and return pipes when the water temperature exceeds boiling point, which is why:

1. It is noisy.
2. It happens in surges, not in a smooth and regular flow.
3. Water can be pushed a long way.

Depending on the amount of water suddenly turned to steam, between 250 ml and 2 litres may be discharged at any one time. In the case of a properly constructed over/under system, it is possible to ensure that none of this water is discharged through the vent pipe, and that all the heated water moved through the system by this mechanism remains within the system.

This process creates a lot of noise, consisting initially of the water boiling, then a small amount turning to steam, and finally that steam pocket collapsing when it mixes with cooler water. When the superheated water and steam hits a much cooler pocket of water, as may be found, for instance, in the heat exchanger coil, the thermal shock creates a pressure wave that accentuates the noises described above, and also gives a physical jolt to the system; over time, these effects may result in some degree of metal fatigue, particularly at joins. They can be quite spectacular and quite disconcerting; they are certainly interesting.

This is the same natural process (and the same physics) that drives geysers in geothermal areas around the world.

The phenomenon of a wetback thermosyphon system 'surging' is well known in the industry, but the reasons for it are little understood, with some manufacturers or industry people advancing a number of hypotheses; some are fanciful and others are simply impossible and contravene the basic laws of physics.

We believe, however, that the above explanation is supported by all the empirical evidence collected as well as personal observations of the many experiments undertaken as a result of this research project. These events can be clearly seen in the graphs generated (see Figures 8, 9) from the data collected for a number of wetback systems tested.

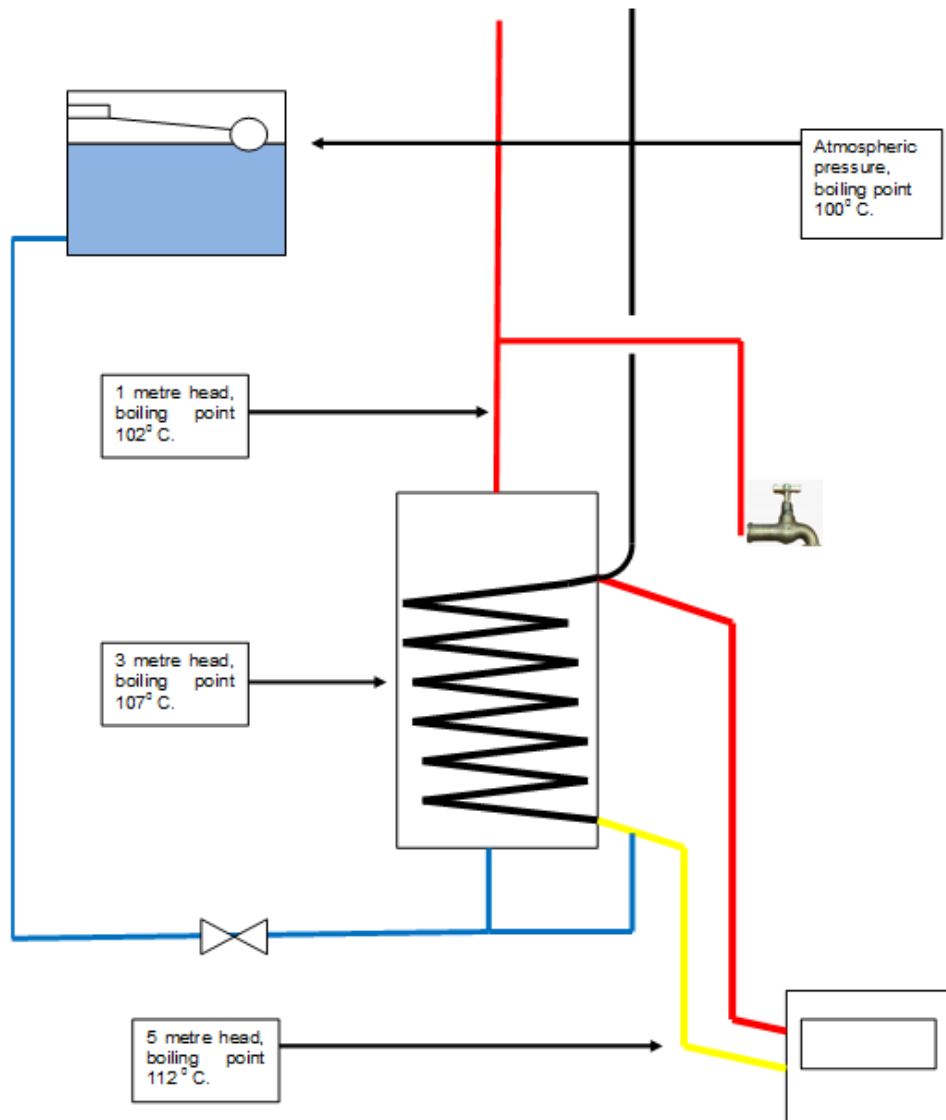

Figure 29. Effect of head on boiling point.

Some of the water gets past the initial boiling point, and may reach further up the pipe where the boiling point is, say, 105°C, which is even more spectacular. The small series of steam explosions causes not just a pocket of steam forcing water before it, but also a thermal shock acting on the pipe. In the case of a coil, this is attached to the wall of the HWC by a bracket welded to the tank.

We consider it inevitable that these repeated thermal shocks will eventually result in the failure of these welds, and for this reason we cannot recommend connecting a wetback to the coil of a stainless-steel cylinder, as stainless-steel welds have a known propensity to fail under thermal stress.

During the period of our project (2014–15) we received a number of phone calls and email correspondence from plumbers who had heard of our research, and who had installed the type of system described above. All were very concerned at the alarming noises regularly emanating from within these cylinders; some had removed them at the request of their customers, who were kept awake by the constant banging.

Combined with the results of efficiency tests comparing the two configurations of indirect systems reported above, we do not recommend indirect wetback systems where the flow and return pipes are connected to the coil, instead believing a direct

connection to the cylinder and the end-use water being run through the coil is the best option; but the coil in that case needs to be sufficiently large to start at the base of the cylinder and exit at the top.

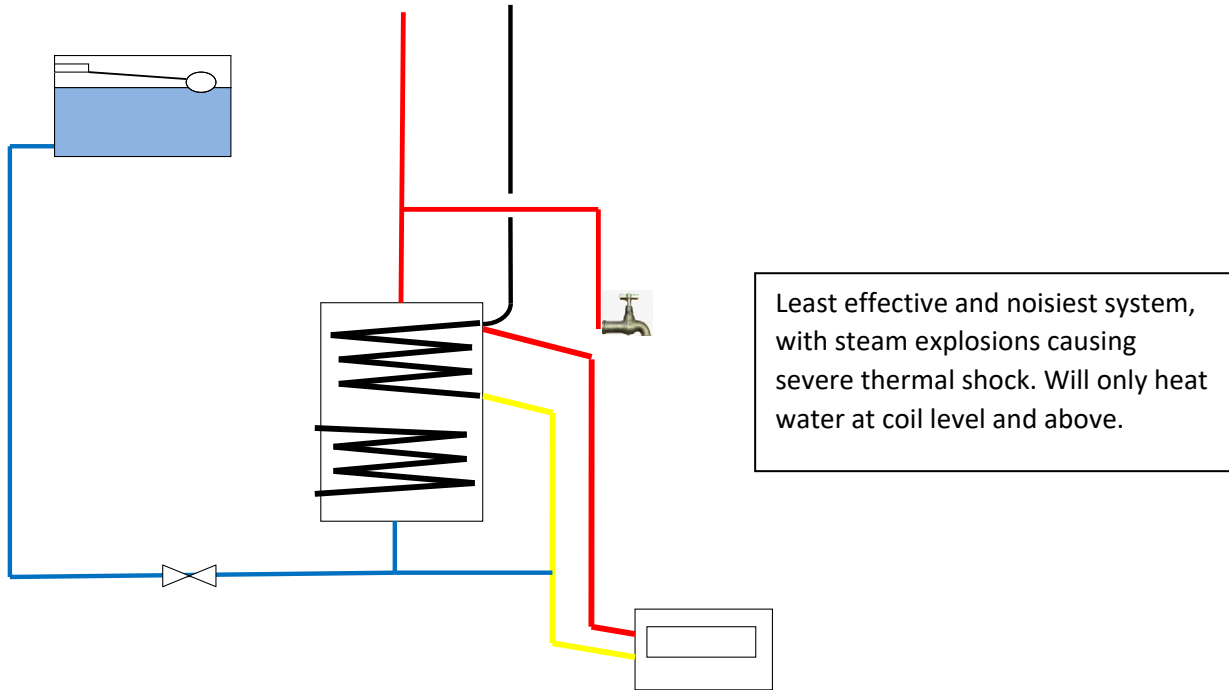

Figure 30. Conventional dual-coil configuration: least effective.

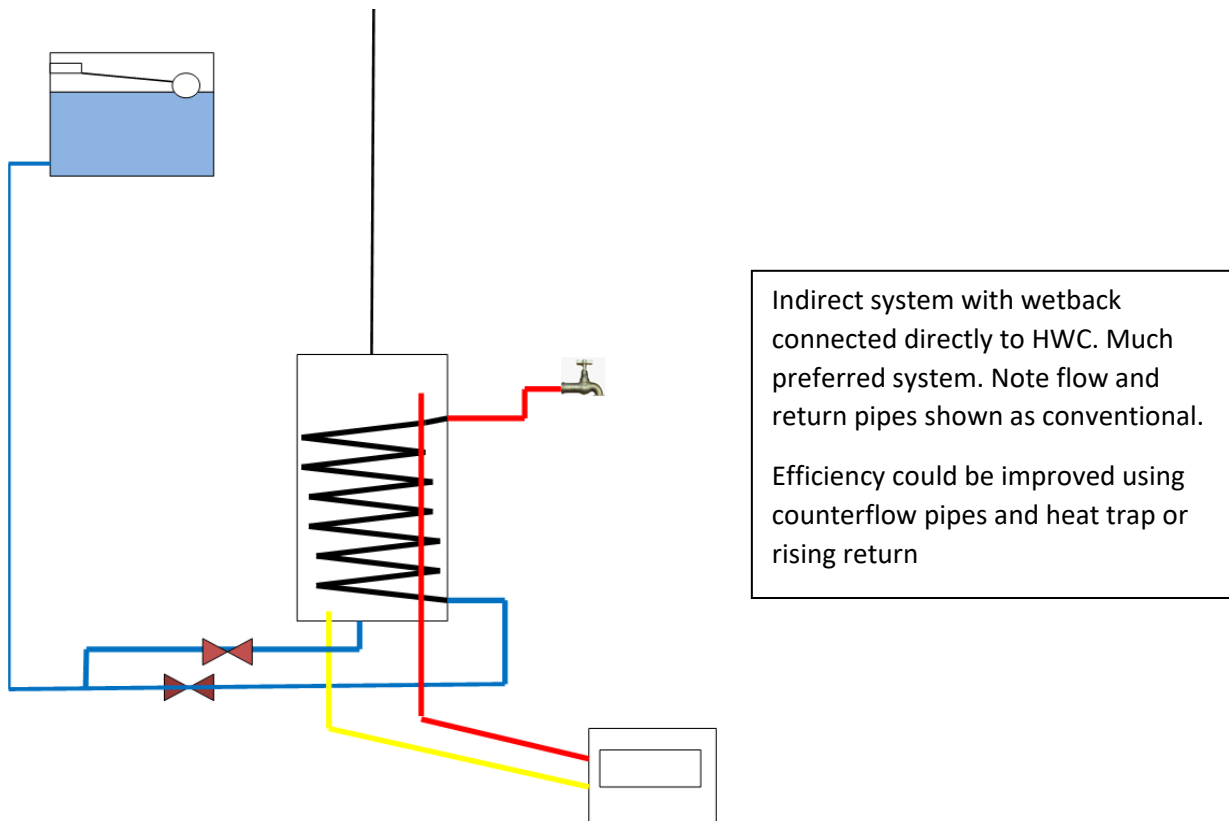

Figure 31. Counterflow system through indirect coil.

The traditional method of connecting a wetback to a coil (heat exchanger) in an HWC is to connect the flow pipe to the top connection and take the return from the bottom, with both the flow and return rising and falling (conventional configuration).

This has led to the issue outlined above, with steam explosions causing both thermal and acoustic shocks (for sound recordings, please contact the corresponding author via the publisher) and, when the water at the top of the HWC was hot enough, considerable loss of heated water through the open vent pipe.

Effective circulation relied on the hottest water going to the top of the HWC, and falling back to the wetback as it cooled. This became less effective as the temperature in the HWC got hotter. So we asked a rather obvious (in retrospect) question: "What if we connected the flow pipe to the bottom connection of the coil?" We reasoned that, in that case, the water would continue to flow, but that as the main body of water at the bottom of the HWC would be coolest, more heat would be drawn from the coil lower down, and by the time it got to the top of the coil more heat might be extracted. To put it another way, by connecting the flow to the hottest part, were we making the heat exchanger less effective? It turns out, yes.

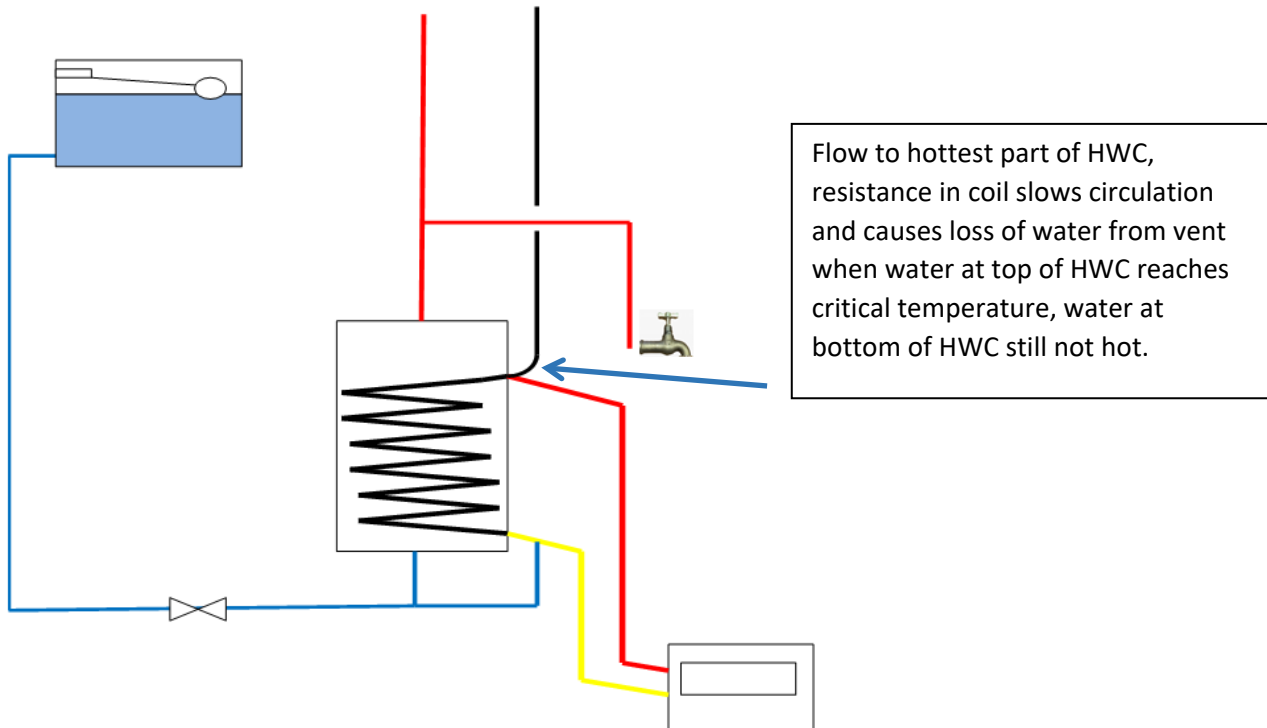

Figure 32. Conventional indirect.

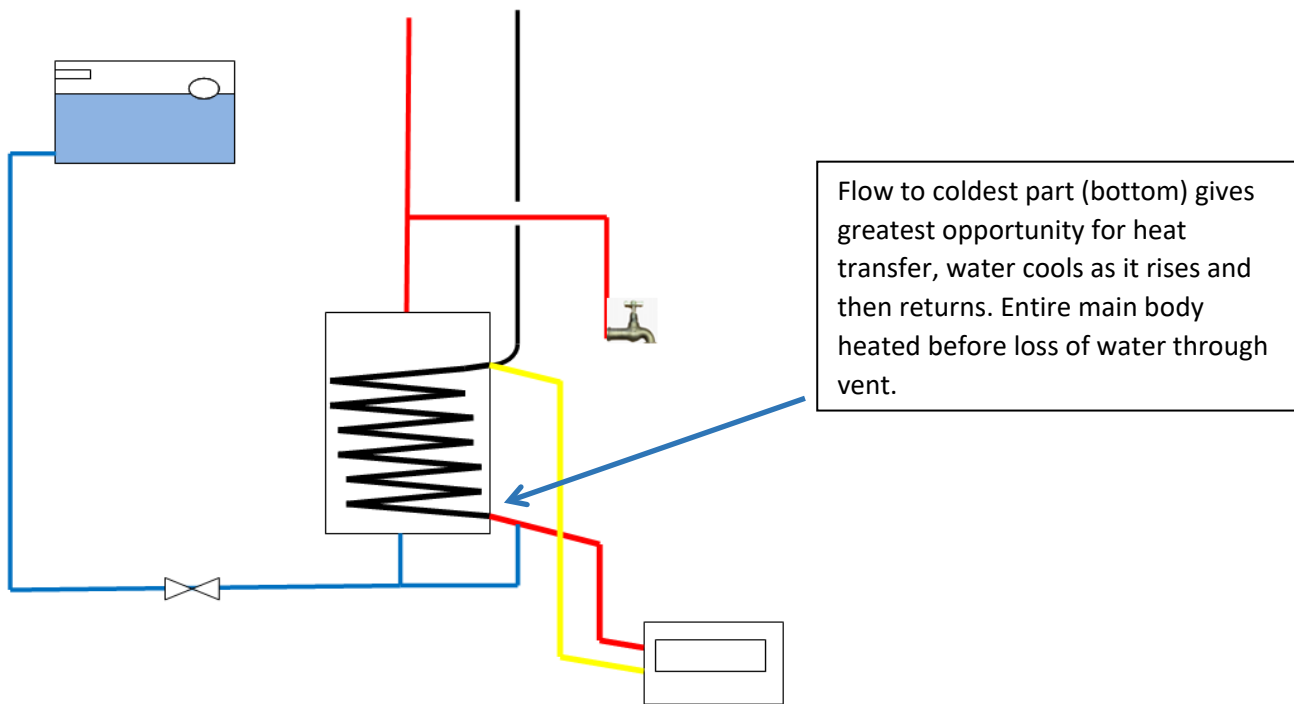

Figure 33. Counterflow indirect.

We found the counterflow arrangement by far the most effective, with less noise and a smoother, more even, heating pattern, with less stratification and less hot water (energy) loss. Additional improvements could be gained by incorporating a heat trap or upward-sloping section connected to the wetback.

Conclusion

Virtually all the requirements and recommendations contained in G12/AS1, AS/NZS 3500.4 and most manufacturers' specifications are wrong. Pipe diameters, gradients and diameter/gradients based on distance appear to have no foundation in fact. While it has been generally believed that an increase in distance requires an increase in pipe diameter to mitigate frictional losses, as stipulated in AS/NZS 3500.4, we found that all this does is vastly increase the mass of water and makes the system less effective.

We also found that requiring the return pipe to 'fall' towards the wetback was also counterproductive, with a rising return or heat trap improving performance.

In addition, the traditional practice of connecting the flow pipe to the top of the HWC (either directly or through a riser pipe within the HWC) was less efficient overall, but we were able to show that it may have limited advantages in the short term if a 'quick recovery' is desired.

We found that in the case of indirect systems incorporating a heat exchanger (coil) in the HWC, direct connection of the wetback to the coil was least effective, and in many cases caused significant problems, including catastrophic failure. For mains-pressure indirect systems, the wetback should be connected directly to the body of water in the HWC (with open vent), with mains-pressure potable supply passing through, and heated by, the coil. This is the opposite to many traditional systems, though was the basis of the original mains-pressure Hunson and Elephant systems.

Other systems: Solar and pumped – extrapolation

Although the research was specifically about natural convection systems using domestic solid-fuel burners, some of the general principles established or confirmed are applicable to other systems. The heat source differs, but the laws of physics apply the same.

SOLAR

The advantages identified for the counterflow method and the use of heat exchanges (the indirect system) will be applicable to a natural-convection solar water-heating system as well.

If the HWC is situated above the panel, then the advantages of connecting the flow (hottest water) to the bottom (coldest part) of the HWC should also apply.

In the case of indirect systems using a coil within the HWC as a heat exchanger, it should be noted that the solar panels are also an uncontrolled heat source as defined in G12. The water in the coil is likely to get very hot, and the ability to transfer this heat most effectively into the main body of water is paramount.

For this reason, we recommended in the case of a solid-fuel heater that the flow (hot) pipe be connected to the bottom of the coil, and the return (colder) water be connected to the top of the coil. We see no reason at all why this principle should not be extended to solar water-heating systems, and welcome further research to confirm this, or otherwise.

PUMPED SYSTEMS

These systems do not depend on natural convection, and also differ materially due to the fact that the circulation is more regular (does not surge) and can be controlled thermostatically. There are potential issues and disadvantages in relying on any mechanical or electronic process, and a power cut or mechanical failure needs to be allowed for by the judicious use of temperature and pressure-relief valves.

We have, however, demonstrated the advantage to heat-transfer systems of delivering the hottest water to the coldest part of the storage tank, and also of heating the main body of water from the bottom upwards. This has advantages over the traditional method of heating the water from the top down, by reducing or eliminating stratification.

We would therefore recommend that all pumped systems also connect as above, using the counterflow method of flow (hot) to the bottom and return (colder) from the top.

Recommendations

As a general set of design principles, we recommend the following eight minimum rules to ensure optimum and safe performance.

1. All flow, return, and vent pipes should be 20 mm copper.
2. All pipes to be fully insulated (lagged) with the best-quality insulation.

3. Flow pipe to rise towards HWC, gradient not critical.
4. Return pipe to rise towards wetback, or incorporate heat trap directly before entering the firebox.
5. Flow pipe should connect to bottom of the HWC, and return pipe to top; i.e., counterflow.
6. Install the vent pipe at highest point of HWC and/or flow pipe if indirect.
7. Vent pipes at the high point of flow pipes to be swept against the flow to reduce water loss.
8. No valves of any sort in circulating pipes.

We recommend that Standards New Zealand and the Ministry of Business, Innovation and Employment work together to agree to a common set of rules for wetback systems, or remove the respective sections from NZBC G12/AS1 completely. Even if they are unwilling to adopt all our recommendations, to have two completely different and contradictory sets of rules is untenable and embarrassing, particularly given neither Standards New Zealand or Standards Australia have been able to explain how or where their designs originated.

A new common set of rules should include:

- Adjacent systems.
- Over/under systems.
- Indirect systems.
- Conventional and counterflow pipe arrangements.

We recommend that textbooks and teaching resources be updated to reflect the research findings.

We recommend that manufacturers of wetback-capable water heaters and storage tanks consider making changes to their products to better reflect more optimal design, and that installation instructions be amended accordingly.

We recommend that Building Consent Authorities accept the designs and principles outlined above as an alternative solution to G12/AS1, until such time as G12/AS1 is changed.

References

- C. F. Reese Plumbing. (2022). *Wetback water heating*. <http://www.cfreese.co.nz/Products/Heating-Hot-Water/Wetback-Water-Heating>
- Doyle, K. (Ed.). (1988–90a). *Plumbing and gasfitting. Volume 1: Trade practice and skills*. GP Books.
- Doyle, K. (Ed.). (1988–90b). *Plumbing and gasfitting. Volume 2: Services and roofings*. GP Books.
- Greenglo. (2011). *User manual, installation instructions, warranty register*. <https://greenglo.co.nz/hot-water-cylinder/wp-content/uploads/2016/08/GreenGlo-Owners-manual-2011-webprint.pdf>
- Level: The Authority on Sustainable Buildings. (2021, January 25). *Wetbacks*. <http://www.level.org.nz/energy/water-heating/energy-sources/wetbacks/>
- Ministry of Business, Innovation and Employment. (2019). *Acceptable solutions and verification methods for New Zealand Building Code Clause G12 Water Supplies*. New Zealand Government. <https://www.building.govt.nz/assets/Uploads/building-code-compliance/g-services-and-facilities/g12-water-supplies/asvm/g12-water-supplies-3rd-edition-amendment-12.pdf>
- Mr Cylinder. (2014, February 27). *What a beautiful wetback installation*. Hot Water Cylinders NZ. <https://www.hotwatercylinders.nz/blog/what-a-beautiful-wetback-installation/>
- Peter Cocks Ltd. (2017). *Installation guide and warranty information*. https://www.petercocks.co.nz/wp-content/uploads/2018/05/PC20INSTALLATION20GUIDE_NOV2020171.pdf
- Pioneer Manufacturing Ltd. (2016). *Metro 3kW or 4kW installation manual*. <https://www.metrofires.co.nz/wp-content/uploads/2019/03/Metro-3kW4kW-Wetback-Installation-Manual-04-16W.pdf>
- Plumbers NZ. (2012). *Wetback installation guidelines*. <https://www.plumbers.nz/q-and-a-wetbacks/61/wetback-installation-guidelines-how-to-install-a-wetback/1137/>
- Pyroclassic Fires. (2016, February 4). *Why buy a Pyroclassic IV wood fire?* <https://www.youtube.com/watch?v=wp4TzEo6CRc>
- Rheem NZ. (2018). *Installation instructions and owner's guide: Rheem low-pressure (copper) electric hot water heaters*. https://rheem.co.nz/assets/technical_documents/Installation-Guides/12da6167b1/INSTALLATION-INSTRUCTIONS-OWNERS-GUIDE-RHEEM-LOW-PRESSURE-COPPER-ELECTRIC-HOT-WATER-HEATERS.pdf
- Rinnai. (n.d.). *Hot water systems*. <https://rinnai.co.nz/water-heating/hot-water-cylinders#mains-pressure-coiled-hot-water-cylinders-tab>
- Standards New Zealand Te Mana Tautikanga o Aotearoa. (2017, April 12). NZS 4603:1985. <https://www.standards.govt.nz/shop/nzs-46031985/>
- Standards New Zealand Te Mana Tautikanga o Aotearoa. (2018). AS/NZS 3500:4. <https://www.standards.govt.nz/shop/asnz-3500-42018/>

Appendix 1. G12/AS1

Extract from New Zealand Building Code G12. These are the full and complete instructions given. Source: Ministry of Business, Innovation and Employment, 2019. Reproduced with permission.

6.13 Wet-back water heaters

6.13.1 Wet-back water heaters shall be:

- a) Connected only to open vented storage water heaters, or a water storage vessel (see Figure 15), and
- b) Made of copper.

6.13.2 Copper pipework shall be used between the wet-back and the water tank.

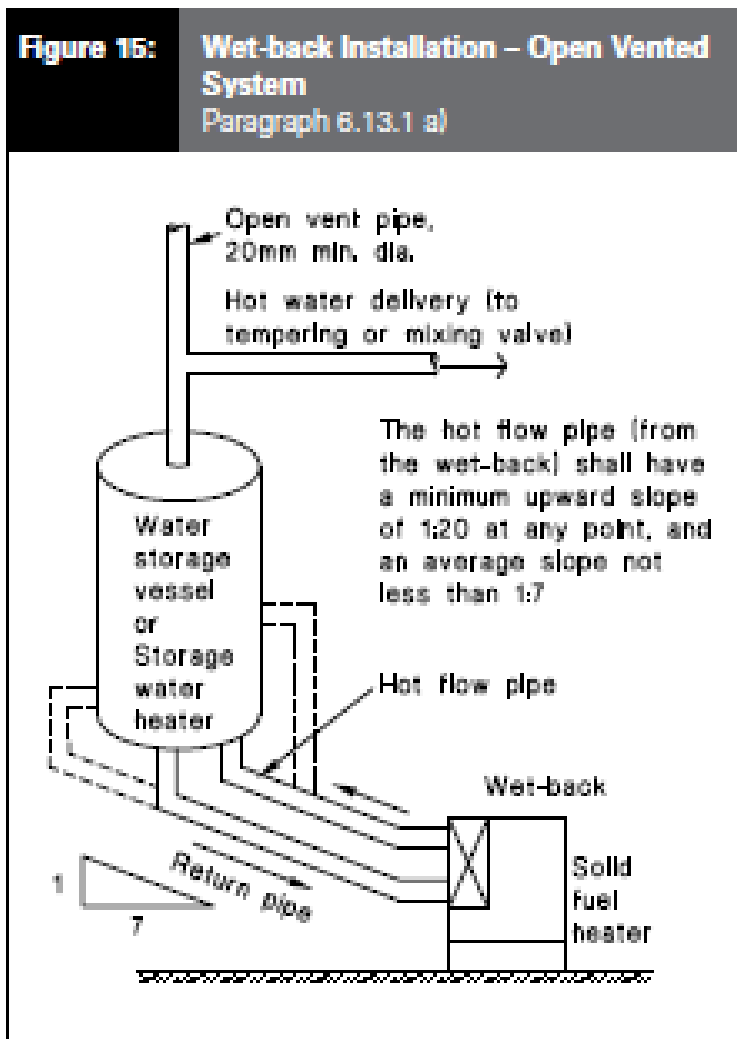

Appendix 2. AS/NZS 3500.4.2018

Extract from AS/NZS 3500.4.2018, Section 7. Source: Standards New Zealand Te Mana Tautikanga o Aotearoa (2018). Copyright in AS/NZS 3500.4.2018 is Standards Australia Limited and Crown copyright, administered by the New Zealand Standards Executive. Reproduced with permission from Standards New Zealand, on behalf of New Zealand Standards Executive, under copyright licence LN001450.

SECTION 7 UNCONTROLLED HEAT SOURCES

7.1 SCOPE OF SECTION

This Section sets out requirements for heated water systems that use uncontrolled heat sources.

7.2 WATER HEATERS WITH UNCONTROLLED ENERGY SOURCE

7.2.1 Installation

The installation of water heaters with an uncontrolled heat input shall conform with the following:

- (a) Thermosiphon water heaters connected to slow combustion stoves or room heaters with water-heating coils, wetback boilers, or the like, shall—
 - (i) have no valves fitted or connected to the primary flow and return pipes between the water heater and the heat source;
 - (ii) have the primary flow and return pipes of a minimum nominal diameter relative to the length, as given in Figure 7.2.1;
 - (iii) have the primary flow and return pipes rise or fall in a continuous gradient;
 - (iv) have the primary flow and return pipes insulated so as not to present a hazard and, where exposed to the weather, have the insulation waterproofed;
 - (v) have the primary flow and return pipes installed in accordance with Figure 7.2.1;
 - (vi) have no dissimilar metals in the primary flow and return lines;
 - (vii) have no elbows fitted in or to the primary flow and return lines; and
 - (viii) have the flow and return line connections made only with unions or similar type couplings.
- (b) Thermosiphon water heaters specified in Item (a), and direct-fired water heaters, shall—
 - (i) be vented to atmosphere with a vent pipe in accordance with Clause 5.12, as appropriate;
 - (ii) be installed so that the maximum working pressure measured at the base of the water container does not exceed 50 kPa; and
 - (iii) be fitted with a tempering valve.

NOTE: For the purpose of this Clause, solar hot water systems fitted with a thermosiphon arrester, a heat dump valve, or a differential pump controller with a high limit cut-out are considered as having a controlled heat source.

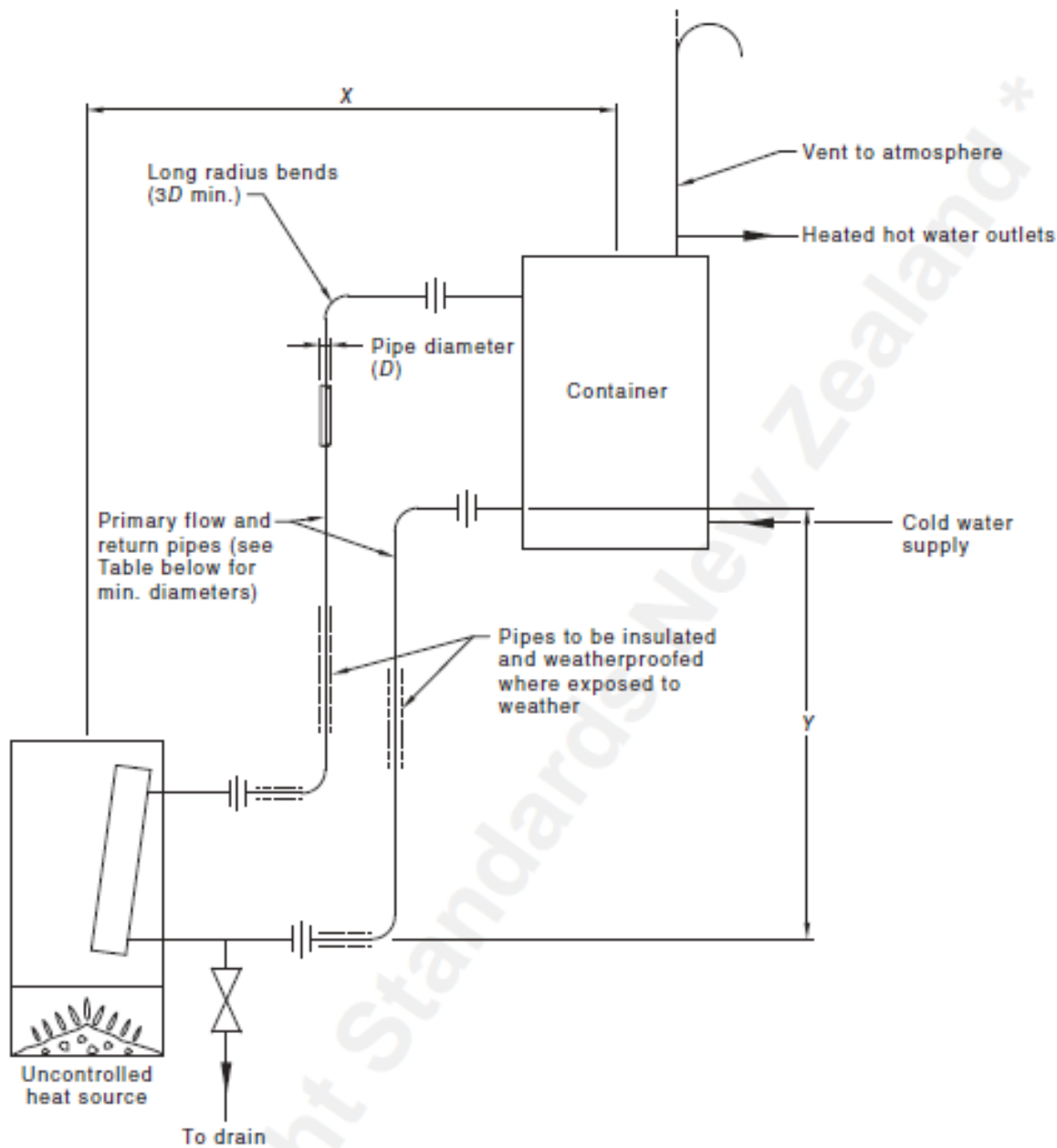

Y	Minimum nominal diameter				
	DN				
	X				
m	2	4	6	8	10
1	20	20	25	32	32
2	20	20	25	32	32
3	20	20	20	25	32
4	18	20	20	25	25
5	18	20	20	20	25
6	18	18	20	20	25

NOTE: Dimensions X and Y are true horizontal and vertical distances, respectively.

FIGURE 7.2.1 PIPE COORDINATES—THERMOSIPHON SYSTEMS

Appendix 3. Schedule of tests

135 L low-pressure HWC with wetback connections and adjacent to heater (standard). Conventional return means rising towards cylinder. The purpose of this group of tests was to compare performance of different types of inserts. 30-second sample rate.									
Date	HWC	Wetback type	Pipe dia.	Horizontal distance	Developed pipe length flow	Developed pipe length return	Total rise of flow pipe	Return detail	Other details
07/07/14	Standard	Ladder	25 mm	1 m	1 m	1.45 m	170 mm	Conventional	Test aborted
07/07/14	Standard	Ladder	25 mm	1 m	1 m	1.45 m	170 mm	Conventional	Unlagged
08/07/14	Standard	Ladder	25 mm	1 m	1 m	1.45 m	170 mm	Conventional	Lagged
09/07/14	Standard	Loop	25 mm	1 m	1 m	1.45 m	170 mm	Level	Lagged
10/07/14	Standard	Loop	25 mm	1 m	1 m	1.39 m	170 mm	Falling	Lagged
10/07/14	Standard	Loop	25 mm	1 m	1 m	1.59 m	170 mm	Rising	Lagged
11/07/14	Standard	Unitec Ladder	25 mm	1 m	1 m	1.65 m	170 mm	Conventional	Lagged
14/07/14	Standard	Box stainless steel	25 mm	1 m	1 m	1.65 m	170 mm	Conventional	Unlagged
14/07/14	Standard	Box stainless steel	25 mm	1 m	1 m	1.4 m	170 mm	Conventional	Lagged
15/07/14	Standard	Unitec Ladder	20 mm	1 m	1 m	1.45 m	170 mm	Conventional	Lagged (repeat test)
16/07/14	Standard	Unitec Ladder	20 mm	1 m	1 m	1.55 m	170 mm	Conventional	Lagged
Indirect system: Rheem stainless steel (SS) with 2 coils, connected to lower coil. Coil also stainless steel. Used Unitec Ladder as it had proved most efficient. According to Rheem, 120–125 litres above coil in cylinder. Term 'falling return' refers to constant grade, 'rising return' means pipe drops to below heater and then rises to wetback.									
Date	HWC	Wetback type	Pipe dia.	Horizontal distance	Developed pipe length flow	Developed pipe length return	Total rise of flow pipe	Return detail	Other details
05/08/14	Indirect SS	Ladder	20 mm	0.7 m	1.4 m	1.7 m	400 mm	Falling	Approx. 10 L lost through vent.
06/08/14	Indirect SS	Ladder	20 mm	0.7 m	1.4 m	2.2 m	400 mm	Falling	20 L lost at 4 hours. Vent 450 above standing water height.
08/08/14	Indirect SS	Ladder	20 mm	0.7 m	1.4 m	2.2 m	400 mm	Falling	Changed vent, sweep away from flow, extended to 1.4 m above standing water height.
14/08/14	Indirect SS	Ladder	20 mm	0.7 m	1400 mm	2.2 m	400 mm	Falling	Repeat above with valve isolating CW inlet to simulate N/R valve.
Indirect Rheem SS with 2 coils, connected 2 coils to form single extended coil. Water not heating below coil so attempt to increase volume heated. Changed to 10-second sampling.									
Date	HWC	Wetback type	Pipe dia.	Horizontal distance	Developed pipe length flow	Developed pipe length return	Total rise of flow pipe	Return detail	Other details
15/08/14	Indirect SS with linked twin coils	Ladder	20 mm	0.7 m	1.4 m	1.5 m	400 mm	Falling	Significant banging and other noises, significant water loss through vent.
21/08/14	Indirect SS, lower coil only	Ladder	20 mm	0.7 m	1.35 m	1.3 m	110 mm	Falling	Significant noise and discharge.

28/08/14	Indirect SS, lower coil only	Ladder	20 mm	0.7 m	1.35 m	1.3 m	110 mm	Falling	Test with containment vessel on vent 590 mm above water level. Recorded steam explosions.
29/08/14	Indirect top coil	Ladder	20 mm	0.7 m	1.35 m	1.3 m	110 mm	Falling	Steam explosion recorded at 4 hours, containment vessel full, significant discharge.

Elephant brand water heater, indirect copper with full height copper coil. Wetback heating cylinder not connected to coil.

Date	HWC	Wetback type	Pipe dia.	Horizontal distance	Developed pipe length flow	Developed pipe length return	Total rise of flow pipe	Return detail	Other details
12/09/14	Elephant	Unitec Ladder	20 mm	0.75 m	1.05 m	1.5 m	250 mm	Falling	2nd data set measuring temperature of water exiting coil @ 12.25 L/m.
15/09/14	Elephant	Unitec Ladder	20 mm	0.75 m	1.05 m	1.5 m	250 mm	Falling	After 2 hours expansion measured at 1 L/hr. Also noted temp. drop overnight (13.3°C).
16/09/14	Elephant	Unitec Ladder	20 mm	0.75 m	1.05 m	1.5 m	250 mm	Falling	Continued from previous day, when water reached boiling point. Major discharge of steam and water – fire alarm activated and building evacuated.

Most previous tests done to time limit, however so many interesting things were happening when water reached boiling point all tests from this point were conducted to maximum temperature to note results and determine cause. Noises of explosions and surges of water. Heat trap designed and fitted to successive tests to determine effect.

Wetback now connected to coil to find difference.

Date	HWC	Wetback type	Pipe dia.	Horizontal distance	Developed pipe length flow	Developed pipe length return	Total rise of flow pipe	Return detail	Other details
18/09/14	Elephant	Unitec Ladder	20 mm	0.75 m	1.05 m	1.5 m	250 mm	Falling	False start on 18/09. Stop and continued on 19/09. Massive water discharges from vent.
22/09/14	Elephant	Unitec Ladder	20 mm	0.75 m	1.05 m	2.39 m	250 mm	Falling	Heat trap fitted to return line at heater.
23/09/14	Elephant	Unitec Ladder	20 mm	0.75 m	1.05 m	1.3 m	250 mm	Falling	Non-return valve in coil, heat trap removed.
24/09/14	Elephant	Unitec Ladder	20 mm	0.7 m	1.1 m	2.4 m	400 mm	Falling	Reverse coil, return to top, flow from bottom. 2.3°C improvement on previous setup.
25/09/14	Elephant	Unitec Ladder	20 mm	0.7 m	1.1 m	2.9 m	400 mm	Falling	Reverse flow with heat trap fitted.
26/09/14	Elephant	Unitec Ladder	20 mm	0.7 m	2 m	1.9 m	400 mm	Falling	Normal connection, flow to top of coil. Heat trap fitted. Violent rumbles and bangs, continuous steam and boiling water discharge when hot.
29/09/14	Elephant	Unitec Ladder	20 mm	0.7 m	1.1 m	2.9 m	400 mm	Falling	Reverse coil, flow to bottom coil. Heat trap.

This group of tests used the Elephant HWC as a direct system, with coil used as heat exchanger for water flow only.

Date	HWC	Wetback type	Pipe dia.	Horizontal distance	Developed pipe length flow	Developed pipe length return	Total rise of flow pipe	Return detail	Other details
------	-----	--------------	-----------	---------------------	----------------------------	------------------------------	-------------------------	---------------	---------------

30/09/14	Elephant direct	Unitec Ladder	20 mm	0.7 m	1.25 m	1.75 m	120 mm	Falling	Heat trap, reverse flow (return to top). Water boiled 4h40, massive discharge 6 hrs. 10 mins continuous.
01/10/14	Elephant direct	Unitec Ladder	20 mm	0.7 m	1.05 m	1.9 m	200 mm	Falling	Conventional flow, heat trap, return to base. Lost water at 6.5 hrs, 120 L approx.
Swapped to Rheem stainless steel (SS) with two indirect coils, low level and mid level. Tests to determine if connection to coil or direct to HWC best.									
Date	HWC	Wetback type	Pipe dia.	Horizontal distance	Developed pipe length flow	Developed pipe length return	Total rise of flow pipe	Return detail	Other details
09/10/14	Rheem SS mid coil	Unitec Ladder	20 mm	0.7m	1.35 m	2.3m	600 mm	Falling	Counterflow (flow to bottom), heat trap. 6 hrs constant discharge from coil and main vents. Serious noises. Pushback into cylinder.
07/11/14	Rheem SS mid coil	Unitec Ladder	20 mm	0.7m	1.35 m	2.3m	600 mm	Falling	Repeat of above with valve to prevent pushback. Discharge and noise recorded.
1/12/14	Rheem SS mid coil	Unitec Ladder	20 mm	0.7m	1.35 m	2.3m	600 mm	Falling	Repeat of above with non-return valve to prevent pushback. 15 mm vent off coil. Discharge and noise recorded. Huge noises and surges.
21/01/15	Rheem SS mid coil	Unitec Ladder	20 mm	0.7m	1.35 m	2.3m	600 mm	Falling	Repeat of above with non-return valve to prevent pushback. 20 mm vent off coil. Discharge and noise recorded. Huge noises and surges. Observations on reasons system inefficient noted.
23/01/15	Rheem SS mid coil	Unitec Ladder	20 mm	0.7 m	1.35 m	2.3 m	600 mm	Falling	Repeat of above with non-return valve to prevent pushback. 20 mm vent off coil. Discharge and noise recorded. Huge noises and surges. Vent pipe fed to supply tank.
28/01/15	Rheem SS mid coil	Unitec Ladder	25 mm	0.7 m	1.5 m	1.4 m	600 mm	Falling	Conventional flow/return, falling return. Major surge at 4 hours. noise noted as alarming with 5 mins surges and water loss.
30/01/15	Rheem SS mid coil	Unitec Ladder	25 mm	0.7 m	1.5 m	2.1 m	600 mm	Rising	Conventional flow. Noted much less noise, some surging, some clanking.
03/02/15	Rheem SS mid coil	Unitec Ladder	25 mm	0.7 m	1.5 m	2.1 m	600 mm	Rising	Counterflow, flow connected to bottom, surge reduced from 15 mins, far less noise, etc., until started to empty through vent at 5.25 hours.

5-month break caused by lack of staff and timetabling issues. When testing restarted most testing from here on done using standard 135 L copper cylinder with bottom-mounted wetback connections with riser. Three thermocouples attached directly to copper skin at bottom, middle and top. This was the original set-up for the first set of comparative tests. At this point we also started to keep a manual record of temperature rises at 15-minute intervals so that a daily comparison with previous test could be kept.

Date	HWC	Wetback type	Pipe dia.	Horizontal distance	Developed pipe length flow	Developed pipe length return	Total rise of flow pipe	Return detail	Other details
01/07/15	Standard	Unitec Ladder	20 mm	0.9 m	1 m	1.2 m	120 mm	Falling	Conventional flow/return, surge noises from 4.5 hours, major water loss at 5 hours. Minimum rise, minimum fall possible.
07/07/15	Standard	Unitec Ladder	20 mm	0.9 m	1 m	1.5 m	120 mm	Rising	Flow pipe minimum rise, return 300 mm rise, reverse to normal. Noise of steam explosions coincided with rise in temp at center of cylinder.
10/07/15	Standard	Unitec Ladder	20 mm	0.9 m	1.25 m	1.56 m	120 mm	Rising (30 mm minimum)	Counterflow system, water above 100°C entering heater and boiling inside cylinder. Water leaving heater above 120°C.
29/07/15	Standard	Unitec Ladder	20 mm	0.9 m	1.3 m	1.9 mm	470 mm	Rising	Counterflow, return rising 450 mm.
31/07/15	Standard	Unitec Ladder	20 mm	0.9 m	1.15 m	2.1 m	470 mm	Rising	Conventional connections, flow and return rise.
03/08/15	Standard	Unitec Ladder	20 mm	0.9 m	1.15 m	1.5 m	470 mm	Falling	Conventional fall and rise as per standards.

A series of tests with cylinder positioned below level of heater. Designed to ascertain whether steam would drive water through system and how that would work. Some lagged, some unlagged. In some tests the 2 vents were combined, or a surge box installed to take surge water – details in written records. Note: this was done due to anecdotal claims of plumbers placing HWC below level of wetback and system still worked. We were skeptical but obliged to try it.

Date	HWC	Wetback type	Pipe dia.	Horizontal distance	Developed pipe length flow	Developed pipe length return	Total rise of flow pipe	Return detail	Other details
05/08/15	Standard	Unitec Ladder	20 mm	0.9 m	1.9 m	1.8 m	Minus 750 mm (below)	N/A	No lagging, noise started within 3 mins. Valve on vent fitted to return pipe. Steam blocked flow pipe 30 mins. Various configurations of valve, stopped trial at 12.30.
4/08/15	Standard	Unitec Ladder	20 mm	0.9 m	1.9 m	1.8 m	Minus 750 mm (below)	N/A	Moved sensors next to wetback crox nuts. Aborted trial due to steam lock in flow pipe.
05/08/15	Standard	Unitec Ladder	20 mm	0.9 m	1.9 m	1.8 m	Minus 750 mm (below)	Same as previous but with supply valve turned off to ascertain whether system will function and water losses reduced.	Water boiled out of W/B at 43 mins, temp at sensor 7 at 171°C. Water turned back on, too dangerous to proceed.

06/08/15	Standard	Unitec Ladder	20 mm	0.9 m	1.9 m	1.8 m	Minus 750 mm (below)	N/A	Surge valve installed. Noise in 3 mins, much worse than previous. At 2 hours calculated at 33% less efficient than conventional. Under pressure steam forced back through surge valve, noises noted as alarming.
07/08/15	Standard	Unitec Ladder	20 mm	0.9 m	1.9 m	1.8 m	Minus 750 mm (below)	N/A	Surge valve replaced with purpose-made restrictor into wetback. Slower heating resulted. Vent from flow pipe connected to HWC vent with specially made fitting. Resulted in loop that heated water at top of HWC, little mixing.
11/08/15	Standard	Unitec ladder	20mm	0.9m	2.05m	1.65m	Minus 750mm (below)	N/A	Counterflow with Sensors 4 and 8 reversed. 4 flow and 8 return at HWC. Noise started at 3 mins.

Proved that cylinder below heater very bad idea, potentially very dangerous, reverted to normal configuration but moved cylinder to 3 m horizontal distance.

Date	HWC	Wetback type	Pipe dia.	Horizontal distance	Developed pipe length flow	Developed pipe length return	Total rise of flow pipe	Return detail	Other details
21/08/15	Standard	Unitec Ladder	20 mm	3 m	2.9 m	4 m	300 mm	Fall, with heat trap.	Conventional flow rise, return fall. Minor noises 4 hours, Direct comparison with 1/07/15. 2 to 3°C less effective than close, 7°C down at 4 hours. Heat loss from 7 m of pipe, lagging hot.
28/09/15	Standard	Unitec Ladder	20 mm	3 m	2.9 m	3.4 m	300 mm	Fall, with no heat trap	Conventional flow rise, return fall.
13/11/15	Standard	Unitec Ladder	25 mm	3 m	2.9 m	3.4 m	300 mm	Changed to 25 mm, no heat trap	Compare directly with 28/09/15. Heating rate difference insignificant.
17/11/15	Standard	Unitec Ladder	15 mm	3 m	2.9 m	3.4 m	300 mm	Changed to 15 mm pipe flow and return, no heat trap	Compare directly to 28/09/15 (20 mm) and 13/11/15 (25 mm). Dribbles and spurts from 5 hours, then continual stream. Slower overall to heat.

Moved cylinder to position 10m from heater. Various configurations. Return pipe run as 'under floor' so level. 20mm and 25mm pipes.

Date	HWC	Wetback type	Pipe dia.	Horizontal distance	Developed pipe length flow	Developed pipe length return	Total rise of flow pipe	Return detail	Other details
23/11/15	Standard	Unitec Ladder	20 mm	10 m	10.2 m	10.5 m	500 mm	Level	Conventional, no heat trap
24/11/15	Standard	Unitec Ladder	20 mm	10 m	10.2 m	10.5 m	500 mm	Level with heat trap	Conventional
25/11/15	Standard	Unitec Ladder	20 mm	10 m	10.5 m	10.5 m	500 mm	Level	Counterflow with heat trap
30/11/15	Standard	Unitec Ladder	25 mm	10 m	10.2m	10.5 m	500 mm	Level	Conventional no heat trap
01/12/15	Standard	Unitec Ladder	25 mm	10 m	10.5 m	10.2 m	500 mm	Level	Counterflow, minimum rise

Cylinder raised onto scaffolding to represent 2nd floor of house. Total height above heater 2.4 m.									
Date	HWC	Wetback type	Pipe dia.	Horizontal distance	Developed pipe length flow	Developed pipe length return	Total rise of flow pipe	Return detail	Other details
10/12/15	Standard	Unitec Ladder	25 mm	10 m	11.8 m	12.2 m	2.4 m	Falling	No heat trap, 2.5 m rise and conventional connections, flow to riser pipe at base going to top of water heater.
14/12/15	Standard	Unitec Ladder	20 mm	10 m	11.8 m	12.2 m	2.4 m	Falling	Identical to above but with 20 mm pipes. No heat trap, 2.5 m rise and conventional connections, flow to riser pipe at base going to top of water heater. Compare to 25 mm.
16/12/15	Standard	Unitec ladder	20 mm	10 m	13.2 m	12.2 m	2.4 m	Return under floor, so dropping 2.4 m then level for 10 m.	Conventional connections, return under floor, so heat trap formed at heater.
17/12/15	Standard	Unitec ladder	20 mm	10 m	13.2 m	12.2 m	2.4 m	Return under floor, so dropping 2.4 m then level for 10 m.	Identical to above but with surge valve fitted.
Now we had data for adjacent systems ranging from 900 mm to 10 m horizontal, and from 15 mm dia to 25mm dia, with rises from 130 mm to 2.5 m. We had also compared conventional (flow to top) and counterflow (flow to bottom), with and without surge valves, and with and without heat traps. We then set up our first over/under systems to ascertain whether general findings from above also applied to these systems. Tested conventional, counterflow, both with and without surge valve.									
Date	HWC	Wetback type	Pipe dia.	Horizontal distance	Developed pipe length flow	Developed pipe length return	Total rise of flow pipe	Return detail	Other detail
18/12/15	Standard	Unitec Ladder	20 mm	10 m	15.8 m	11.3 m	Level (floor level)	Level under floor	Conventional connections, with surge valve, max height of flow pipe above base of cylinder 3.7 m.
18/01/16	Standard	Unitec Ladder	20 mm	10 m	15.8 m	11.3 m	Level (floor level)	Level under floor	Same as above, no surge valve. Slightly less efficient. No effect on noise or surging.
19/01/16	Standard	Unitec Ladder	20 mm	10 m	16 m	11 m	Level (floor level)	Level under floor	Counterflow system, flow to base, return from top, no surge valve fitted.
20/01/16	Standard	Unitec Ladder	20 mm	10 m	15.8 m	11.3 m	Level (floor level)	Level under floor	Counterflow system, flow to base, return from top, surge valve fitted, slightly less efficient.

Appendix 4. Recommended systems

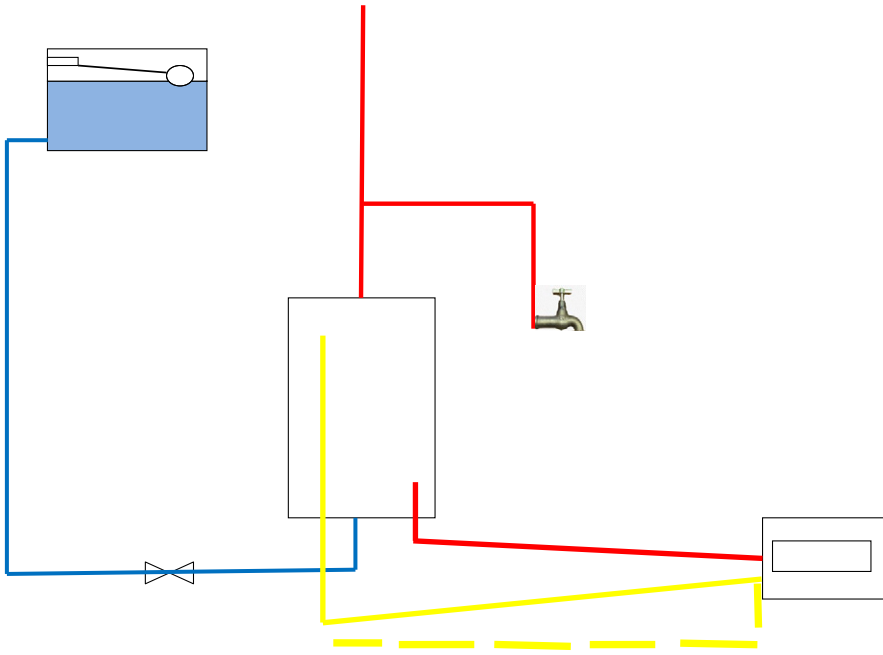

Adjacent direct (rising return). Alternatively, form a heat trap.

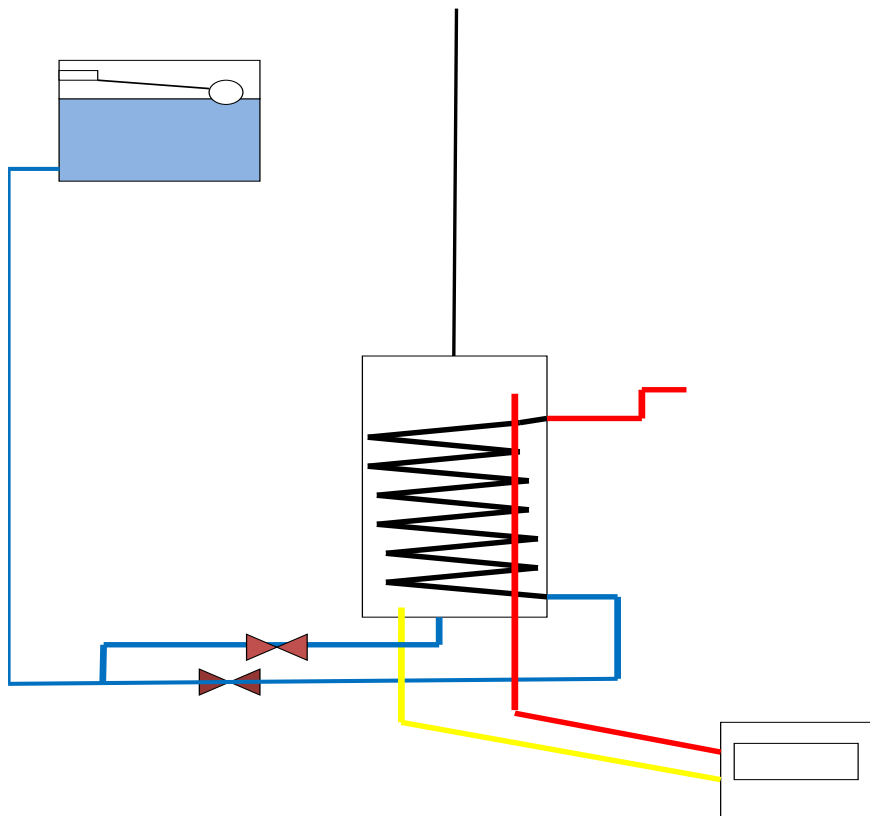

Adjacent indirect.

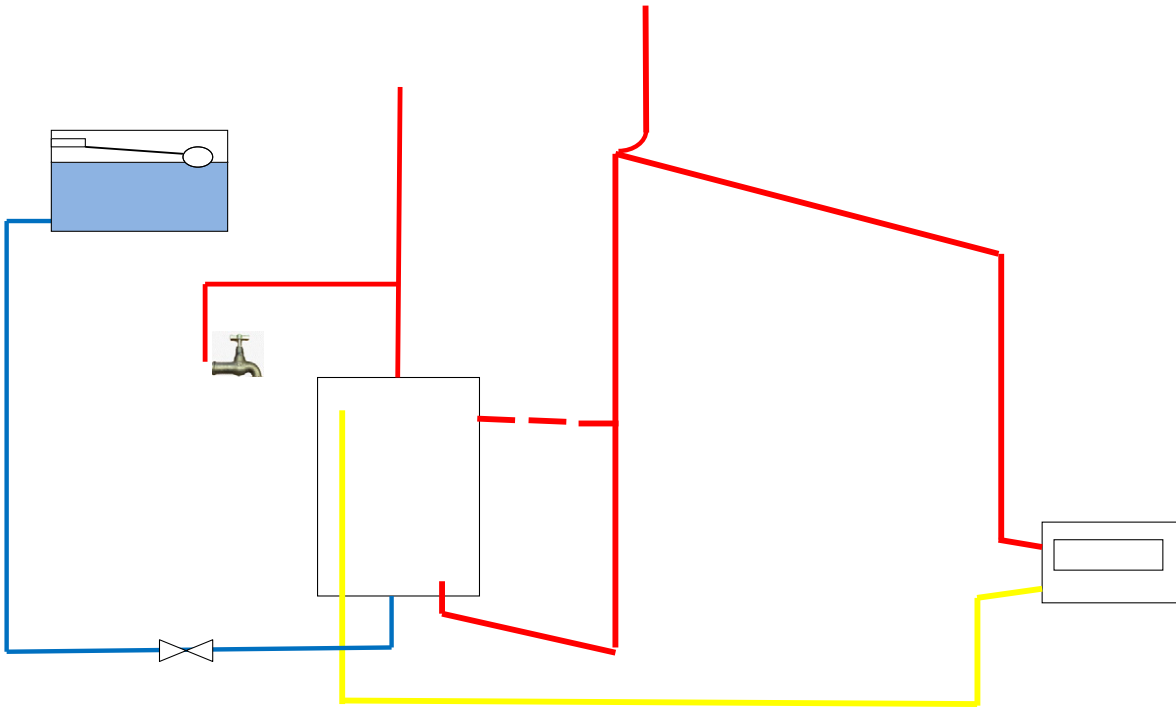

Over/under system.

Note swept junction for vent at high point of flow line (alternative connection point).

Appendix 5. General photos



Data logger showing temperatures at all sensors.



First test run, without lagging.



Elephant indirect with heat trap, flow and return connected to coil, conventional.



Rheem double coil, comparing rising and falling return pipe.



Boiling water discharged through vent pipe being captured and measured.



Pipework pre-lagging.

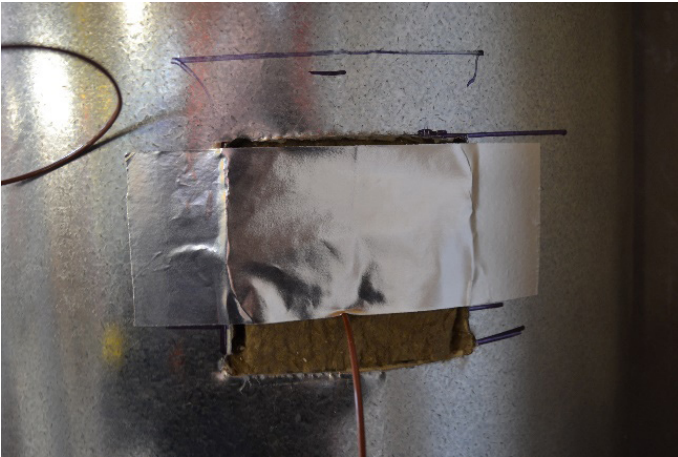

Thermocouple attached to skin of water cylinder and then sealed with new insulation. Top, middle and bottom of each cylinder.

Other thermocouples attached to pipework. Thermocouple in heater to check temperature inside heater was constant.

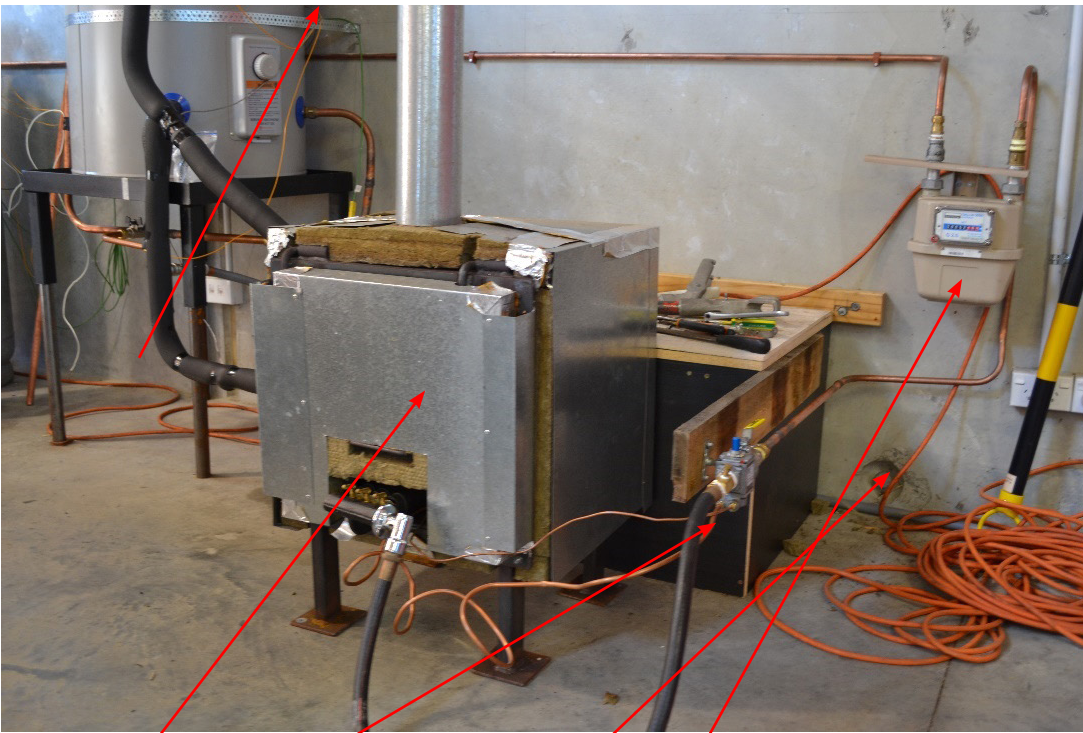

Purpose-built heater, burner, flame-failure device, gas valve with test point, gas meter. Heater was gas rated for every test to ensure constant heat input for every test.



Water cylinder at 10 m distance raised 2.4 m above floor level.



Wetback pipes at 10 m distance, conventional connections.

